

# INLINE HOCKEY NEW ZEALAND

**RULE BOOK 2021 - V1 (Second Edition)**

---

---





# CONTENTS

TERMINOLOGY .....	4
GLOSSARY .....	5
1 GENERAL GAME REGULATIONS .....	8
1.1 Eligibility of Teams and Players .....	8
1.2 Game Time and Time Outs .....	8
1.3 Tied Games .....	8
2 FACILITIES .....	9
2.1 Rink .....	9
2.2 Goal Cages .....	9
2.3 Goal Crease .....	10
2.4 Face-off Spots and Circles .....	10
2.5 Referee's Crease .....	10
2.6 Player Benches .....	11
2.7 Penalty Bench .....	11
2.8 Signal and Timing Device .....	11
3 TEAMS .....	12
3.1 Team line-up .....	12
3.2 Player Equipment .....	12
4 GAME OFFICIALS .....	15
4.1 General .....	15
4.2 Referees .....	15
4.3 Official Scorer .....	16
4.4 Game Timekeeper .....	16
4.5 Penalty Timekeeper .....	16
4.6 Goal Judges .....	16
5 GAME PROGRESS .....	18
5.1 Pre-Game Procedures .....	18
5.2 Warm-Up .....	18
5.3 Starting Line-Up .....	18
5.4 Start of Game and Periods .....	18
5.5 General Game Rules .....	18
6 PENALTIES .....	23
6.1 Penalty Definition .....	23
6.2 Management of Penalties .....	26
6.4 Implementation of Penalties .....	28
7 DISCIPLINE .....	41
7.1 General .....	41
8 SANCTIONS .....	42
8.1 Forfeiture .....	42
8.2 Suspension .....	43
9 DISPUTES .....	44
9.1 Protests .....	44
Annex A RINK DIAGRAM .....	46
Annex B PENALTY SIGNALS .....	49
Annex C PENALTY INDEX .....	52

# TERMINOLOGY

## **IHNZ**

Inline Hockey New Zealand or the New Zealand Inline Hockey Association as described in the Constitution

## **TEAM ORGANISATION**

The maximum number of players is limited to 14 floor players and two goalkeepers all identified by the same uniform. The minimum number of players on a team would be six players (including the goalkeeper).

## **TEAM PLAYING**

At no time shall any team have more than five players on the floor during a game. To officially start a game a team must be able to put on the floor at least four skaters and one goalkeeper, or five skaters and no goalkeeper

## **PROTESTS**

A protest is not valid unless made on the rink by the Team Captain of the protesting team to the Lead Referee who will immediately inform the Captain of the opposing team. In the case of administrative protests (bad state of the rink, player's equipment, unqualified players etc) only those made to the Lead Referee BEFORE the start of the game are valid, the Referee will then advise the Captains of both teams that the game is being played under protest. All protests must be confirmed by official letter addressed to IHNZ within one and a half hours after the game

## **APPEALS**

If a matter arises which is not covered by any rules, or if a difference of opinion arises over the imposition of sanctions, then any such matters will be resolved by the IHNZ Board in accordance with the IHNZ Disputes and Disciplinary Policy. Appeals may be subject to fees for IHNZ Sanctioned events as outlined in the specific event notice designed for each event

## **REFEREE**

There should be two referees in each game. They will share responsibilities; however, the first one listed on the game sheet is designated Lead Referee, to be the final authority on violations that involve controversy. The Lead Referee shall be in complete control of the game, players, all other officials, spectators and venue, responsible only to the jurisdictional authority of the appropriate controlling body and the Lead Referee's game decisions shall be final

## **SCOREKEEPER**

This Official keeps a record of all scores, penalties, shots on goal and any other information required on the official game sheet

## **TIMEKEEPER**

This Official times all playing periods

## **PENALTY TIMEKEEPER**

This Official keeps the time of all penalties assessed by the Referees and monitors the penalty bench

## **GOAL JUDGE**

This Official signals shots on goal that either scored a goal or those that did not

## **SLIDE PLATE TECHNOLOGY**

This refers to equipment that is attachable to the goalkeeper's leg pads that support lateral movement. This includes (and is not limited to) Rollerfly, Dekgoalie or Rollheim products

# GLOSSARY

## **APPROPRIATE AUTHORITIES**

Inline Hockey New Zealand (IHNZ)

## **ALTERCATION**

The physical interaction between two or more opposing players which, result in a penalty or penalties being assessed

## **BARRIER**

In the form of railing walls or boundary markers which identify the outer edge of the playing surface

## **BREAK-AWAY**

Occurs when a player is in control of the puck with no opposition between the player and the opposing goal, with a reasonable scoring opportunity

## **BUTT ENDING**

Occurs when a player uses the shaft of the stick above the upper hand to jab or attempt to jab an opposing player

## **CENTRE FACE OFF SPOT**

The exact centre from both end and sides of the playing area

## **COACH**

A Coach is a person primarily responsible for direction and guiding the play of the team. Along with the Manager, the Coach is responsible for the conduct of the team's players before, during and after the game

## **CREASE**

The Goalkeepers area marked on the playing surface in front of each goal designed to protect the goalkeeper's from interference by attacking players

The Referees area marked on the playing surface in front of the Penalty Timekeeper's seat for the use of the Game Official's

## **CROSS-CHECKING**

Occurs when a player, holding the stick with both hands, checks an opponent by using the shaft of the stick with no part of the stick on the playing surface

## **DEFLECTING THE PUCK**

Occurs when the puck makes contact with any person or object, causing it to change direction

## **DIRECTING THE PUCK**

The act of intentionally moving or positioning the body, skate or stick so as to change the course of the puck in a desired direction

## **FACE OFF SPOTS**

The spots at either end and in from the sides of the playing area

## **FACE OFF**

Any time the puck is being brought back into play by the Referee during the course of the game. The Referee will drop the puck on the face off spot from approximately waist height between two players. Each standing on their own defensive side of the face off spot, with their sticks held on the floor either side of the spot. All players must stay on their defensive side until the puck has been legally dropped at which time the puck is in play for all players

## **FIGHTING**

Occurs when the actual throwing of a closed fist punch or punches by a player whom makes contact with an opponent

**GOAL CAGE**

The net enclosed framework at each end of the playing area, into which the puck must pass to score a goal

**GOALKEEPER**

The player(s) assigned and equipped to the position of defending one's own goal. Considered a player except where special rules specify otherwise

**GOALKEEPER'S PRIVILEGED AREA**

The area bounded at the rear by the goal line, at the front by an imaginary line connecting the two end face off spots at that end and at the sides by imaginary lines perpendicular to the goal line and extending to the end face off spots

**HEAD BUTTING**

Occurs during the physical use of one's head in the course of delivering a body check (head first) in the chest, head, neck or back area, or the physical use of the head to strike an opponent

**HECC**

The Hockey Equipment Certification Council is an independent organization responsible for the development, evaluation and testing of performance standards for protective hockey equipment. Equipment that is approved by HECC is highly recommended for all players

**HEEL OF THE STICK**

The point where the shaft of the stick and the bottom of the blade meet

**HOOKING**

Occurs when a player applies the blade of the stick to any part of an opponent's body or stick and impeding the progress by a pulling or tugging motion with the stick

**PENALTY**

A penalty is the result of any personal or technical infraction of the rules by a player or Team Official as decided by the Referee. It usually involves the removal from the game of the offending player or Team Official for a specified period of time.

**PLAYER**

A member of a team who is physically participating in a game (the goalkeeper is considered a player except where special rules specify otherwise)

**POSSESSION OF THE PUCK**

The most recent player or goalkeeper to have made contact with the puck, this includes a puck that is deflected off a player or any part of the equipment

**POSSESSION AND CONTROL OF THE PUCK**

The last player or goalkeeper to make contact with the puck and who also propels the puck in a desired direction

**POWER PLAY**

A team has a Power Play when it has, on the playing floor, numerically more floor players than the opposing team is entitled to have. Thus, if a team elects to replace its goalkeeper with a floor player, then that team does NOT have a power play

**PROTECTIVE EQUIPMENT**

Equipment worn by players for the sole purpose of protection from injury

**SHORTHANDED**

Shorthanded means that a team is below the numerical strength of its opponent on the playing surface

**SLASHING**

Occurs when a player strikes or attempts to strike an opponent with a stick or swinging a stick at an opponent with no contact being made

**SPEARING**

Occurs when a player pokes or attempts to poke an opponent with the tip of the blade of the stick while holding the stick with one or both hands

**SUBSTITUTE GOALKEEPER**

A designated goalkeeper on the Official Score Sheet who is not participating in the game

**TEAM OFFICIAL**

A person responsible in any way for the operation of a team, such as a Team Manager, Coach or Trainer

**TEMPORARY GOALKEEPER**

A player not designated as a goalkeeper on the Official Score Sheet who assumes that position when no designated goalkeeper is able to participate in the game. The temporary goalkeeper is governed by goalkeeper privileges and limitations, and must return as a player when a designated goalkeeper becomes available to participate in the game

# 1 GENERAL GAME REGULATIONS

## 1.1 Eligibility of Teams and Players

- a) IHNZ sanctioned events are open to the Teams of all Member Clubs affiliated with IHNZ, provided that they maintain their requirements as described by the IHNZ Constitution, confirm their entry prior to the closing date for entries laid down by IHNZ and forward payment of appropriate entry fees
- b) Players must be registered with an IHNZ member club in order to participate in any IHNZ sanctioned event.
- c) Playing grades shall be determined by the Board and may be amended from time to time at the Board's discretion.

## 1.2 Game Time and Time Outs

- a) Regulation games will be played in two periods of twenty (20) minutes each, with a five (5) minute rest at half time after which the teams shall change ends.
- b) Each team shall be permitted one time out of one minute duration per period.

## 1.3 Tied Games

- a) If, at the end of a game, the score is tied, the game shall be called a "tie" and each team shall be credited with one point in the standings, except for single elimination matches where ties are not desirable at the end of regular playing time.
- b) For games where a tie is not desirable (pre-quarter finals, quarter-finals, semi-finals and finals, or other types of single elimination competitions), the outcome of the game shall be settled as follows:
  - At the conclusion of the tied match, a three minute rest will be allowed, and the teams will play a ten minute sudden death playoff, with the announcement that the first team to score will be declared the winner.
  - If after the sudden death overtime period the teams are still tied, the teams will proceed to a Shootout to determine the winner (See 2.3 e)
- c) Any overtime period shall be considered a part of the game and all unexpired penalties shall remain in force.
- d) Overtime periods do not apply to games tied in round robin matches.
- e) Shoot-out: When additional game time is not available for sudden death overtime, a shoot-out can be used to break ties for teams having equal accumulated points.
  - Shootouts will take place using three shooters from each team, with each team alternately participating , in conformity with procedures used for penalty shots. The Captains will nominate the shoot out participants to the Lead Referee. The Lead Referee shall give the list of shooters to the Scorekeeper prior to the start of the shootout.
  - Team Captains will use a coin toss prior to the start of the shoot-out to determine which team will initiate the alternating sequence of shots. Each goalkeeper will defend that teams' own goal and a common goal cage is not to be employed.
  - The highest number of successful goals obtained from the three attempts will determine the victor in the shoot-out.
  - If the result is still tied after three shots by each team the procedure shall continue with a tie-break shoot-out by one player of each team, with new players with the other team starting to take the tie-break shots. The game shall be finished as soon as a winner between the 2 players brings the decisive result.



## 2 FACILITIES

### 2.1 Rink

- a) Inline Hockey shall be played on sport tile, wood, asphalt, cement or any appropriate surface approved by the Inline Hockey Technical Commission.
- b) The ideal size of the rink is 50x25 metres (164x82 feet). However, dimensions of the surface may vary between 40 and 60 metres in length (131 to 197 feet) and 20 and 30 metres in width (66 to 98 feet). As much as possible, an attempt should be made to maintain a width versus length ratio of 1:2.
- c) The rink shall be marked accordingly to the diagram included with the rules taking into consideration the exact dimensions indicated herein. A centre red line should be marked on the floor to distinguish the defending zone and the attacking zone.

NOTE: there are no other line markings required on the playing surface for inline hockey

- d) The rink be surrounded by a wood or fibreglass wall (boards) that extend above the rink surface from 101 to 122 cm (40 to 48”), with the ideal height being 107cm (42”). The barrier shall have rounded corners of a radius of approximately five metres (16 feet) to facilitate keeping the puck in play.
- e) Rinks of the size prescribed in 2.1b may not be available for all games within the jurisdiction of IHNZ. In such instances, variations in the size (surface area) of rinks and the marking of goal lines and face off circles, proportionate to the overall size of the playing surface are authorised by IHNZ. If such a rink will be used as a venue for any competition, its dimensions must be included with the information sent out to invited member clubs (in fairness to the participants).

### 2.2 Goal Cages

- a) There must be two goal nets, one at either end of the floor.
- b) The goal net is comprised of a goal frame and netting.
- c) The open end of the goal net must face the centre of the floor.
- d) Each goal net must be located in the centre of the end red line and must be installed in such a manner as to remain stationary during the progress of the game.
- e) The goal posts must extend vertically 1.22 metres above the floor and be 1.83 metres apart (internal measurements). The goal posts and crossbar that form the tubular steel goal frame must be of a specified design with a diameter of 5 cm.
- f) The goal posts and crossbar must be red. All other parts of the goal net and frame must be white.
- g) The goal posts and crossbar must be completed by a white frame inside the base of the goal frame along the floor and top extending from post to post towards the end boards 24 and supporting the netting, the deepest point of which should be between 0.6-1.12 metres.
- h) A netting of durable white nylon cord must be attached securely over the entire back of the goal frame in such a manner as to trap the puck in the goal net after it has entered, and to prevent the puck from entering the goal net in any way other than in front.
- i) Referees are required to check the netting before the start of each period of play. If they find any damage to the netting, game action cannot begin until the necessary repairs have been made.
- j) The inside parts of the supports of the white frame, other than the goal posts and the crossbar, must be covered by white padding. The padding of the base frame must start not less than 10 cm from the goal post and must be attached in a manner that does not restrict the puck from completely crossing the goal line.
- k) Drop netting that stops airborne pucks before they reach the back of the goal is recommended but not required.

- l) The goal cage consists of an iron pipe cage with a rectangular face opening with inside dimension height of 105 cm (41") and inside width of 170 cm (67") as shown in the inset diagram.
- m) The front or facing frame must be made with iron galvanized pipe of 7.6 cm (3") diameter. The top and base supports and the back brace shall consist of iron pipe 5 cm (2") diameter. The bottom or supporting base of the goal cage shall extend in depth to 109 cm (43") outside dimensions from the face of cage to the centre of the back arc. The top supporting frame shall be 74 cm (29") in outside depth dimensions. A 5 cm (2") supporting brace at the back centre of the cage shall connect the top and bottom frames. The top, posts and internal face of the goal cage must be covered with very resistant netting, which has yarn dense enough to resist the strongest shots, and closely woven so as not to permit through passage of the puck. Metallic netting will not be allowed.
- n) A drop net must be suspended from the near inside top of the cage with a depth of 45 cm (18") measured from the top cross bar of the goal. This cotton netting, thinner than the outside (external) one, has a maximum width of 180 cm (71") and height of 110 cm (43"), must be suspended inside the cage to prevent the puck rebounding from the inside of the goal. This net must be white in colour and should be attached at the top only, allowing it to hang freely to the ground parallel to the posts of the cage. The posts and front bar must be painted in a fluorescent red or orange colour while all other framing parts should be painted in white. It is required that the bottom rail of the goal cage and the back-centre brace be padded to resist having the puck bounce back out of the cage after a hard shot.
- o) The goal cages are placed opposite at each end of the rink with openings facing each other. The distance from the goal line to the extreme end of the rink is 3.8 metres (12.5 feet) or as appropriate in accordance with rule 2.1e.

### 2.3 Goal Crease

- a) In front of each goal, a "Goal Crease" area shall be marked by a red line 5 cm (2") wide. This line shall extend at a right angle from a point on the goal line, 30 cm (1 foot) from the outside of each goal post for a distance of 1.2m (4 feet). A line parallel to the goal line shall join the ends of these two lines. Or, be a line in the shape of a semi-circle with a radius 1.09m that shall be marked on the floor immediately in front of the goal. It shall be understood that the area covered by the goal crease on the floor shall extend to all the space above the crease.

NOTE: The goalkeeper's privileged area shall be defined as the area that extends between the end zone face off spots and back to the goal lines. Refer to the rink diagram. The goalkeeper shall be allowed to freeze the puck provided part of his body is in the privileged area.

- b) The goalkeeper shall be allowed to freeze the puck behind the goal line or to the sides of the goal net provided part of his body is in contact with the goal crease. If the goalkeeper causes a stoppage of play by freezing the puck outside the goal crease or privileged area a minor penalty shall be assessed.

### 2.4 Face-off Spots and Circles

- a) The rink will be marked with a total of five face-off positions.
- b) One face-off spot, 22.5 cm in diameter (9"), shall be placed at the exact centre of the floor, surrounded by a three metre radius circle (10 feet).
- c) In each end zone, two 22.5 cm (9") face off spots will be placed, located 6.1 metres (20 feet) out from each goal line and 6.7 metres (22 feet) from the exact centre of the rink's width, along an imaginary line parallel to the goal line. This would make the spots 13.4 metres (44 feet) apart from each other. A 3 metre (10 feet) radius circle shall be drawn around each spot.

### 2.5 Referee's Crease

- a) A line in the shape of a semi-circle and with a 3-metre (10 feet) radius shall be marked on the floor immediately in front of the Penalty Time-keeper's bench. Players are restricted from entering this area during stoppage of play without permission from the Referee.

## **2.6 Player Benches**

- a) It is recommended that each rink should have seats or a bench for the use of each team, to be known as the “Player Benches.” Each player bench shall accommodate at least sixteen persons and shall be placed immediately alongside the playing surface as near as possible to the centre of the rink and convenient to the dressing rooms.

## **2.7 Penalty Bench**

- a) It is recommended that each rink will have seats or benches to be known as the “Penalty Bench.” It is to be used for the seating of penalized players, alongside the Penalty Timekeeper, Game Timekeeper and Official Scorer. The penalty bench should be located a substantial distance from the player benches. It is preferred that the Penalty Benches be located on the opposite side to the Player Benches.

## **2.8 Signal and Timing Device**

- a) Each rink must have a suitable sound device to be used by the Game Timekeeper. An electric timing device shall be provided for the purpose of keeping participants informed as to the various timed elements of the game. The timing display shall indicate the time remaining to be played and penalty time to be served.

## 3 TEAMS

### 3.1 Team line-up

#### 3.1.1 Players

- a) Team rosters will consist of a minimum of six players (including the goalkeeper) and a maximum of 14 floor players and two goalies.
- b) Once the IHNZ sanctioned event has begun, no roster substitutions or the addition of extra players are permitted.
- c) In acknowledgement to the preceding minimum roster requirements, a game nevertheless shall not be forfeit or a team disqualified, unless the team falls below the size causing forfeiture as contained in clause 8.1.

#### 3.1.2 Team Captain and Alternate Captains

- a) One Captain shall be appointed by each team.
- b) Each team should have a Captain on the floor at all times. If a Permanent Captain is not on the floor, Alternate Captains (not more than three) shall be accorded the privileges of the Captain.
- c) No goalkeeper shall be entitled to exercise the privileges of Captain or Alternate Captain on the floor.
- d) Only the Captain or Alternate Captain on the floor at the time of the stoppage of play (but not both) shall have the privilege of discussing with the Referee any point relating to the interpretation of rules.

### 3.2 Player Equipment

#### 3.2.1 General

- a) All equipment, with the exception of puck and skates will be regulation Inline Hockey equipment.

#### 3.2.2 Sticks

- a) The sticks shall be inline hockey-style made of wood or other approved material and must not have any projections.
- b) Adhesive tape of any colour may be wrapped around the blade for the purpose of reinforcement or to improve control of the puck.
- c) No stick shall exceed 1.57m (63") in length from the heel to the end of the shaft, nor be more than 32 cm (12.5") from the heel to the end of the blade. The curvature of the blade of the stick shall not be restricted. The blade of the floor players' stick must be a minimum of 5 cm (2") and may not exceed 9 cm (3.5") in width at any point.
- d) The blade of the goalkeeper's stick may not exceed 13 cm (5") in width at any point except at the heel where it must not exceed 14 cm (5.5") in width; nor shall the goalkeepers stick exceed 39 cm (15") in length from the heel to the end of the blade.

#### 3.2.3 Skates

- a) Skates to be used will be in-line skates designed for Inline Hockey only and may consist of either three or four wheels for floor players.
- b) Goalies may, as an option, use 'five wheel' inline skates with smaller wheels, provided that all wheels are contained beneath the goalie boot and do not protrude either front or back.
- c) If skates are manufactured for a specific number of wheels, all wheels must be in place. All wheel bolts and axles must be recessed and even with the frame or covered with protective material so as not to injure other players or mark the skating surface.
- d) No quad or conventional skates will be permitted in IHNZ sanctioned events, although individual Member Clubs may allow the use of quad or conventional skates for any local play.

### 3.2.4 Protective Equipment

- a) All players, except goalkeepers, must wear shin guards, elbow pads, approved hockey gloves, approved helmets, face protection and protective cup (if male) or pelvic protective equipment (if female) at all times during the game.
- b) A glove from which all or part of the palm has been removed or cut to permit the use of bare fingers shall be considered illegal equipment.
- c) The goalkeeper must wear a chest protector which conforms to the body, regulation goalkeeper's gloves, approved face mask and protective cup (if male) or pelvic protective equipment (if female). If the goalkeeper wears forearm guards they must be soft and pliable and conform to the player's forearms. Any regulation Inline Hockey style equipment is acceptable.
- d) Full-face protection must be attached to the helmet for everyone playing in an IHNZ sanctioned event that is under the age of nineteen. This regulation applies to both men and women players. For all players nineteen (19) years of age and older, the mandatory equipment includes a helmet with Half Visor minimum.

NOTE: Visor must be worn properly as it is intended. Any visor worn in the offset position (i.e. tilted up exposing the eyes) during play will be given a Team warning. Any subsequent infractions by the same team will result in a minor penalty for illegal equipment assessed to that player.

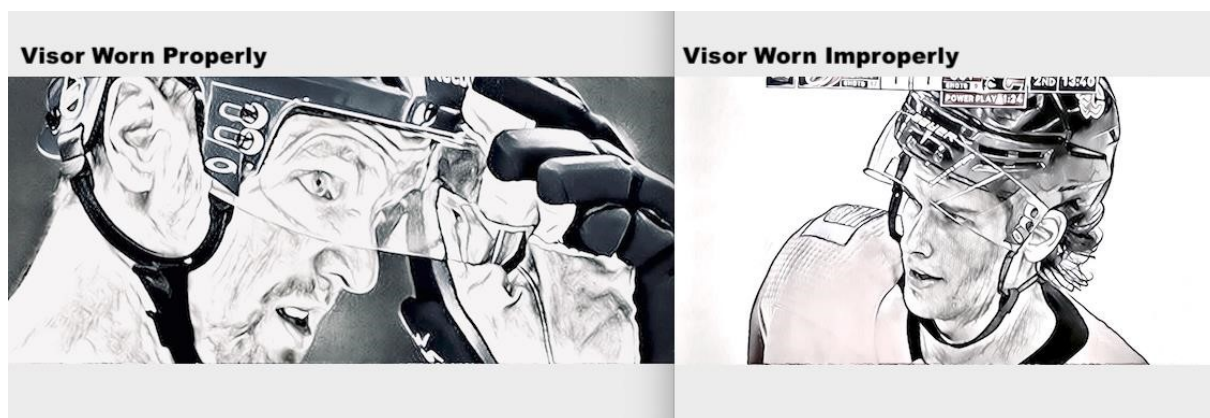

- e) A mouth guard is recommended for players wearing a half visor.
- f) Helmets of players shall be properly fastened with a chin strap.

NOTE: Full-facial protection is mandatory for ALL male and female Junior players under the age of 19 playing in any IHNZ sanctioned events.

### 3.2.5 Goalkeeper's Equipment

- a) With the exception of skates and sticks, all equipment worn by the goalkeeper must be constructed solely for the protection of the head or body and must not include any garment or contrivance which would give the goalkeeper undue assistance in keeping a goal from being scored.
- b) "Slide plate" technology designed for Inline Hockey shall be permitted in all IHNZ sanctioned events.
- c) The lacing, webbing or other material joining the thumb and index finger of the goalkeeper's glove or any cage, pocket or pouch created by this material, must not exceed the minimum amount of material necessary to fill the gap between the thumb and the index finger when they are fully extended and spread.
- d) Protective padding attached to the back of, or forming part of, the goalkeeper's gloves shall not exceed 20 cm (8") in width or 40 cm (16") in length.
- e) Abdominal aprons extending down the thighs or the outside of the pants are prohibited.
- f) Goalkeeper's pads when new shall not exceed 30 cm (12") in extreme width as measured on the goalkeeper and shall not be altered in any way.

### 3.2.6 Approval of Protective Equipment

- a) Helmets and face protection of players, as well as face masks of goalkeepers shall be HECC/CSA/CE approved.

### 3.2.7 Wearing of Protective Equipment

All protective equipment except gloves, helmet and facial protection and goaltender leg pads must be worn entirely under the uniform. Leather elbow patches on the outside of the jersey are prohibited.

### 3.2.8 Dangerous Equipment

- a) The use of pads or protectors made of metal or any other material likely to cause injury to a player is prohibited.

NOTE: All elbow pads which do not have a soft protective covering of sponge rubber or a similar material shall be considered dangerous equipment.

- b) Eyeglass wearers must have plastic, not glass, lenses in their eyewear.
- c) Any player wearing non-standard or additional protective devices prescribed by a physician must have the permission of IHNZ prior to playing.

### 3.2.9 Uniforms

- a) All players participating in contests will be uniformed and have two jerseys of different colours.
- b) Uniforms will require identical long-sleeve shirts and full-length pants. Goalie jerseys will be the same colour and design as other team members.
- c) Each player and goalkeeper listed in the line-up of each team shall wear an individual identifying number at least 20 to 25 cm (8 to 10") high on the back of the jersey. The numbering sequence must be from 1 to 99. No number shall have a "0" in front. (e.g. 2 not 02).
- d) No two members of the same team will be assigned or permitted to wear the same number. Individual player's numbers may not be changed or substituted after the preliminary team registration without the approval of IHNZ.
- e) One team Captain and three Alternate Captains shall have a small "C" or "A" on the left shoulder of their jersey.
- f) Players are permitted to wear tape on their playing pants and jersey but must use clear tape.

### 3.2.10 Allocation and Colours of Uniforms

- a) It will be the responsibility of the home team to change its jerseys if the colours of the competing teams conflict. The decision in this matter shall be left to the Referees in charge of the game.
- b) Team jerseys must match in style and colour.

### 3.2.11 Uniform Inspection

- a) The officials in charge of the game shall perform equipment inspection prior to the start of the game. No penalty shall be charged to a player before the start of the game for wearing equipment not in conformity with the rules. Wearing of illegal or dangerous equipment after the start of the game shall be corrected according to the rules.

### 3.2.12 Puck

- a) The puck shall be the puck approved by IHNZ.
- b) The home team or host shall be responsible for providing an adequate supply of official pucks.
- c) This supply of pucks shall be kept at the penalty bench under the control of one of the Game Officials.

## 4 GAME OFFICIALS

### 4.1 General

- a) There will be two Referees used in each game.
- b) The additional required Game Officials include an Official Scorer, Game Timekeeper and a Penalty Timekeeper. The Penalty Timekeeper will be responsible for notifying the players of the expiration of their penalty time.
- c) If the rostered Game Officials arrive after the game has commenced they may or may not replace the substituted officials. This decision will be made by IHNZ or Tournament Representatives.

### 4.2 Referees

- a) Two Referees appointed by IHNZ will be used in all sanctioned events.
- b) If a Referee cannot appear for the match, IHNZ shall appoint another Referee.
- c) One Referee will be named by IHNZ as the Lead Referee. This will be the first Referee named on the Official Scoresheet.
- d) The Referees shall have similar duties, but in areas of controversy the decision of the Lead Referee will be final.
- e) A Lead Referee shall have full authority and final decision in all matters of dispute. The Lead Referee's decision shall be final on all questions of fact and not subject to appeal.
- f) The Lead Referee shall have the final decision on all goals, disputed or not and may consult with the other Referee and goal judge (if used) before giving the final decision.
- g) The Referees are the official representatives of IHNZ. They shall be in full control of players on and off the floor. Game officials and the officials connected with the competing clubs and the Referees will be backed to the limit in all legitimate circumstances.
- h) All Referees shall be dressed in black pants, an approved Referee jersey and equipped as approved by IHNZ.
- i) The Referees in charge shall have no affiliation with either team.
- j) All Referees and other game officials must be treated with courtesy at all times during the tournament by all players and officials from all Member Clubs. Any infraction of this rule will be reported to IHNZ which may assess such penalties as the infraction warrants.
- k) The Referees shall call the teams to the floor at the appointed time for the commencement of the game, the second period and any overtime period.
- l) The Referees shall check the equipment worn by any player when requested to do so by the manager or coach of either team. This request must be made through the Captain or Alternate Captain.
- m) The Referees shall assess all penalties as prescribed by the rules. The Referees shall report to the Official Scorer the assessment of any penalties including the infraction, and duration of the penalty. The Referee shall also report the player who is to be credited with the scoring of a goal and who is to be credited with the assist.
- n) The Referees shall remain on the floor at the conclusion of each period, and any overtime, until the players have proceeded to their benches or dressing room.
- o) After each game, the Referees shall check and sign the Official Score Sheet and return it to the Official Scorer.
- p) Referees are required to report on the Official Score Sheet all Game Ejections, Game Misconduct, Gross Misconduct and Match penalties as well as any unusual delays in the game. They should report these immediately following the game involved giving full details to IHNZ. Such reports are to be confidential.

### **4.3 Official Scorer**

a) The Official Scorer shall:

- Prior to the start of the game, obtain from the Manager or Coach of each team the complete line-up. The Captains/Alternate Captains of each team shall be duly noted on the official score sheet.
- Submit the complete line-up of the competing teams to the Referee prior to the start of the game and draw to the Referee's attention any circumstance which the Official believes does not comply with the rules.
- Enter into the official score sheet a correct record of the goals scored, who scored, and to whom credit is given for assists, if any.
- Where a public address system is used, may announce, or have announced, immediately following the scoring of each goal, the name of the player who scored the goal, and the name of each player who received an assist.
- Record the saves by each goalkeeper as reported to them by the goal judge. If there are no goal judges then it is the responsibility of the scorer to record and track saves.
- Keep a correct record of all penalties assessed stating the names and numbers of the penalised players, the duration of each penalty, the infraction and the time the penalty was assessed.
- Advise the Referee when the same player has received a second or third penalty or a second misconduct penalty in the same game.
- At the completion of each game, sign the Official Score Sheet and have the Referee check over and sign it too. The Official Scorer shall then forward the score sheet to the designated IHNZ member.

### **4.4 Game Timekeeper**

a) The game timekeeper shall:

- Record the time of the starting and finishing of each game, and all actual playing time during the game.
- Signal the Referee for the commencement of the game, the start of the second period and for each overtime period. If the rink is not equipped with an automatic buzzer, gong or siren, or if this equipment should fail to operate, the game timekeeper shall, by means of a whistle, signal the end of each period, each overtime period, and the end of the game.
- Record the time of goals and penalties in minutes and seconds from the time on the game clock.
- Record the time outs called by each team.

### **4.5 Penalty Timekeeper**

a) The penalty timekeeper shall:

- Keep the time served by each penalized player during the game and upon request inform the penalized player of the unfinished penalty time.
- If a player leaves the penalty bench before the penalty time has expired, note the time and signal the Referee who will stop the play as soon as possible.
- Where public address systems are used, announce or have announced the name of each penalized player, the nature of the offense and the penalty assessed.

### **4.6 Goal Judges**

a) The use of goal judges and their positioning will be at the discretion of IHNZ.

b) They shall not be members of either competing team nor shall they be replaced during the progress of the game unless it becomes apparent that either goal judge on account of



partisanship or any other cause is guilty of giving unjust decisions. In such cases the Lead Referee may appoint another goal judge to act in that person's place.

- c) Each goal judge must be stationed in the designated area behind the goal and off the playing surface for the duration of the game and shall not change ends at any time after the games begins. Their jurisdiction is limited to that game only. The duties of a goal judge are as follows:
- To check the net to make sure there are no holes that the puck can get through.
  - To see that at all times the goal cage is kept in its correct position of the floor.
  - To extend both hands above the head when the puck has completely crossed the goal line.
  - To extend their arms straight out from their sides if a shot is made on goal which does not score.
  - To assist the Referee on a decision as to whether an opposing player was in the crease before the puck entered the crease.
  - To extend one arm above the head to signal to the Referee when the goalie has frozen the puck and it becomes unplayable.
  - To keep an accurate count of saves by the goalie and report to the scorekeeper at the end of the half and end of the game.

NOTE: A save is only when the puck that would have entered the net is stopped by the goalkeeper.

## 5 GAME PROGRESS

### 5.1 Pre-Game Procedures

- a) Prior to the start of the game, the Manager or Coach of each team shall list the players, goalkeepers and Captain/Alternate Captains who shall be eligible to play in the game. This list must be given to the Official Scorer.
- b) These players' names must be included on the original team roster submitted at the beginning of the Championship.
- c) No change in the game list or additions shall be permitted after the commencement of the game except when a goalkeeper has been injured or becomes ill. The name of another goalkeeper must be designated on the list when submitted to the Official Scorer. However in cases where a substitution for the injured or ill goalkeeper must take place; such substitution can only be made by a player already on the list.

### 5.2 Warm-Up

- a) All players must be in full uniform including protective equipment to take the floor for warm-ups.
- b) During the pre-game warm-up and before the commencement of play in any period, each team shall confine its activity to its own half of the rink.

### 5.3 Starting Line-Up

- a) Prior to the start of the game, the Manager or Coach of each team is required to name the starting line-up to the Referee or the Official Scorer.
- b) To start a game, both teams must have a goalie and four skaters, or five skaters and no goalie on the floor at the Referee's whistle to start the game.

### 5.4 Start of Game and Periods

- a) Before starting the game, the Referees shall see that the appointed Official Scorer, Game Timekeeper, Penalty Timekeeper and Goal Judges are in their respective places.
- b) The game shall start at the time scheduled by a "face-off" in the centre of the rink as will the beginning of the second half of the game, after each scored goal and before sudden death play-offs.
- c) No delay shall be permitted by reason of any ceremony, exhibition, demonstration or presentation unless prior approval has been given in advance by the Tournament Director.
- d) The two teams will start at the opposite end zone of their respective player's bench.
- e) Only players in uniform, the Manager, Coach and other Registered Team Officials (total of five non-playing) shall be permitted to occupy the player benches.
- f) During the game, Coaches, Managers and Team Officials shall be restricted to the use of the area the length of the player's benches, including their team gate. Penalty for violation of this rule is a Bench Minor Penalty. The only exception to this will be when called onto the rink by the referee(s) to assist with an injured player.

### 5.5 General Game Rules

#### 5.5.1 Face-Offs

- a) A team shall be required to place the correct number of players on the surface when requested to do so by the Referee. The visiting or away team must be first to place any playing line-up on the surface to commence play at all times.
- b) Players facing-off will stand facing their opponent's end of the rink approximately one stick length apart with the full blade of their stick on the floor. All other players must be at least three meters (10 feet) away from the players facing-off and they must be on-side.

- c) The blade of the players stick must touch the floor for the face-off.
- d) In the conduct of any face-off anywhere on the playing surface, players shall not make any physical contact with an opponent's body by means of their own body or by their sticks except in the course of playing the puck after the face-off has been completed. For violation of this rule the Referee shall impose a Minor Penalty or Penalties on the player(s) whose action(s) caused the physical contact.

NOTE: "Conduct of any face-off" commences when the Referee designates the place of the face-off and the puck is dropped. Once a team is in face-off position, the puck could be put into play within five seconds.

- e) If a player facing-off fails to take a proper position immediately when directed by the Referee, the Referee may order that player replaced for that face-off by any teammate then on the floor.
- f) When an infringement of a rule has been committed or a stoppage of play has been caused by any player of the attacking side, the ensuing face-off shall be made on the centre face-off spot.

NOTE: This includes stoppage of play caused by a player of the attacking side shooting the puck on to the back of the defending team's net without any intervening action by the defending team.

- g) When an infringement of a rule has been committed by players of both sides in the play resulting in the stoppage, the ensuing face-off will be made at the nearest face-off circle to where the play was stopped or in cases where play is permitted to be completed unless otherwise expressly provided by these rules.
- h) When stoppage occurs between the end face-off circles and near the end of the rink the puck shall be faced-off at the end face-off spot on the side where the stoppage occurs unless otherwise expressly provided by these rules.
- i) When a goal is illegally scored as a result of the puck being deflected off the Referee directly into the net, the face-off shall be at either of the face-off spots in that zone.
- j) To avoid gatherings and potential altercations after stoppages in play, if the attacking teams point players enter a gathering of defending players in the attacking end zone the ensuing face-off shall take place at the centre face-off circle.
- k) When the game is stopped for any reason not specifically covered in the Official Rule Book the puck must be faced-off where it was last played.

#### 5.5.2 Time Outs

- a) A time-out may be only be called by the Captain or Alternate Captain at a stoppage of play. The play will then resume with a face-off.
- b) One time-out of one-minute duration for each team per half will be available. A game time out may be called by the Referee at any time during the game.
- c) When a team has called a time-out, the teams may go to their player bench.
- d) No time-outs shall be allowed during an overtime period.

#### 5.5.3 Adjustment to Clothing and Equipment

- a) Play shall not be stopped, nor the game delayed by reason of adjustment of clothing, equipment, skates or sticks.
- b) The responsibility of maintaining clothing and equipment in proper condition shall be upon the player. If adjustments are required, the player shall retire from the floor and play shall continue without interruption using a substitute.

NOTE: If a player loses a helmet in the "process of a play" that player must retrieve that helmet and immediately fasten that helmet onto his or her head or proceed directly to the players' bench. A violation will result in a two minute Minor Penalty for improper equipment.

NOTE: However, a goalkeeper, after a stoppage of play, with the permission of the Referee, may be allowed to make adjustments or repairs to clothing, equipment or skates. Goalkeepers may also be permitted by the Referee to replace their goalie mask but no time shall be allowed for repair or fitting a mask.

#### 5.5.4 Change of Players

- a) When play is in progress, not more than four floor players and one goalie are permitted on the playing surface at any one time.
- b) Players may be substituted at any time from the player benches, provided that the player or players leaving the surface shall be within 3m (10') of their player's bench before any change is made.
- c) The goalkeeper may be removed and another "player" substituted. Such substitute shall not be permitted the privileges of the goalkeeper.
- d) When a goalkeeper leaves the goal area and proceeds to the player's bench for substitution, this must be done within 3m (10') of the bench area before the substitute may enter the game.
- e) Players on the penalty bench, who are to be substituted after the penalty has expired, must proceed by the way of the playing surface and be at their own player's bench before any substitution can be made.
- f) If the team substituting has possession of the puck and the substitution is made prematurely, the official shall stop play immediately and a face-off will take place at either the centre face-off spot or end zone face-off spot (whichever location gives advantage to the non-offending team). If the team does not have possession of the puck and makes an illegal substitution, the Referee shall assess a Minor Penalty.
- g) For player changes during stoppages of play, the Referee conducting the face-off will assume the Referee's normal position for the ensuing face-off. The Referee not conducting the face off shall allow a five second interval during which the visiting team may make a change of players. After this five second interval has elapsed, the Referee not conducting the face off shall raise an arm to indicate that the visiting team may no longer change any players. With the arm still raised, the Referee shall allow the home team the opportunity to make a change of players (if they have not already done so). After another five seconds time interval, the Referee not conducting the face off shall drop the arm. This will indicate that the home team may no longer change any player(s).
- h) The Referee at the face off location shall blow the whistle and within five seconds drop the puck. When a team attempts to make a player change after the allotted time intervals, the Referee shall send the player(s) back to their bench. Any subsequent infraction of this procedure shall result in a Bench Minor Penalty.

NOTE: A change of players shall include one to all four skaters on a stoppage of play. Once a team has used its allotted time for their change they shall not be entitled to make additional changes.

- i) Each team is allowed only one change of players during a stoppage of the play.

#### 5.5.5 Goalkeeper

- a) Each team shall be allowed one goalkeeper on the floor at one time.
- b) Any substitute goalkeeper entering the game for any reason shall not be permitted a warm-up.

#### 5.5.6 Injured Players

- a) When a player, other than a goalkeeper is injured or compelled to leave the floor during a game, the player may retire from the game and be replaced by a substitute, but play must continue without the teams leaving the floor.
- b) If a goalkeeper sustains an injury or becomes ill, the goalie must be ready to resume play immediately or be replaced by a substitute goalkeeper and NO additional time shall be allowed by the Referee for the purpose of enabling the injured or ill goalkeeper to resume position. No warm-up shall be given to the replacement goalkeeper.

- c) The substitute goalkeeper shall be subject to the regular rules governing goalkeepers and shall be entitled to the same privileges.
- d) When a substitution for the regular goalkeeper has been made, such regular goalkeeper shall not return to the game until the first stoppage of play thereafter.
- e) When a player is injured so that the skater cannot continue play or go to the team bench, the play shall not be stopped until the injured player's team has secured possession of the puck. If the player's team is in possession of the puck at the time of injury, play shall be stopped immediately, unless the injured player's team is in a scoring position.
- f) A player other than the goalkeeper whose injury appears serious enough to warrant a stoppage of play may not participate further in the game until the completion of the ensuing face-off.

NOTE: In a case where it is obvious that a player has sustained a serious injury, the Referee may stop the play immediately regardless of who is in possession of the puck.

#### **5.5.7 Puck Must Be Kept In Motion**

- a) The puck must be kept in motion at all times.
- b) With the exception of being able to carry the puck behind its own goal one time, a team in its own defence area which is in possession of the puck shall always advance the puck toward the opposing goal, except when prevented from doing so by players of the opposing side or if that team in possession is short-handed.
- c) For the first infraction of this rule play shall be stopped and a face-off will be taken at the spot adjacent to the goal of the team causing the stoppage and the Referee shall warn the Captain or Alternate Captain or the offending team of the reason for the face-off. For a second violation by any player of the same team in the same period a Minor Penalty shall be imposed on the player violating the rule.
- d) A minor penalty shall also be imposed on any player who deliberately holds the puck against the boards in any manner unless the player is being checked by an opponent.
- e) For an infringement of this rule the face-off shall be at the nearest end face-off spot adjacent to the offender's goal.

#### **5.5.8 Kicking the Puck**

- a) Kicking the puck shall be permitted in all zones, but a goal may not be scored by an attacking player kicking the puck into the goal.

#### **5.5.9 Puck Out of Bounds or Unplayable**

- a) When the puck goes outside the playing area to either end, or either side of the rink or strikes any obstacles above the playing surface other than the boards, glass or wire it shall be faced-off at the nearest circle where it was shot or deflected, unless otherwise expressly provided in these rules.
- b) When the puck becomes lodged in the netting on the outside of either goal so as to make it unplayable, or if it is frozen between opposing players intentionally or otherwise, the Referee shall stop the play and face-off the puck at either of the adjacent face-off spots. If in the opinion of the Referee, the stoppage was caused by a player of the attacking team, the resulting face-off shall be conducted at the nearest face-off spot adjacent to the goal of the offending player or centre face-off spots.

NOTE: This includes stoppage of play caused by the player of the attacking side shooting the puck onto the back of the defending team's net without any intervening action by the defending team.

- c) The defending team and/or the attacking team may play the puck off the net at any time. However should the puck remain on the net for longer than three seconds play shall be stopped and a face-off shall take place in the end face-off zone except when the stoppage is caused by the attacking team, then the face-off shall take place on the face-off spot at the centre circle.
- d) If the puck comes to rest on top of the boards surrounding the playing area it shall be considered to be in play and may be played legally by hand or stick.

#### **5.5.10 Puck Out of Sight and Illegal Puck**

- a) Should a scramble take place or a player accidentally falls on the puck and the puck is out of sight of the Referee, the Referee shall immediately blow the whistle and stop play. There will be a face-off at the nearest face-off spot.
- b) If at any time while play is in progress a puck other than the one legally in play shall appear on the playing surface the play shall not be stopped but shall continue with the legal puck until the play in progress is completed by change of possession. At the Referee's discretion if the legal puck is interfered in play, the Referee shall stop the play immediately.

#### **5.5.11 Goals and Assist**

- a) A goal shall be scored when the puck has been put between the goal posts by the stick of a player of the attacking side from in front, and below the cross bar and entirely across the line the width of the diameter of the goal posts drawn on the floor from one goal post to the other.
- b) A goal shall be credited on the Official Score Sheet, to a player who shall have propelled the puck into the opponent's goal.
- c) When a player scores a goal, ONE assist shall be credited to the player who made the pass leading to the scoring of the goal.
- d) A goal shall be scored if the puck is put into the goal in any way by a player of the defending side. The player of the attacking side who last played the puck shall be credited with the goal but no assist shall be awarded.
- e) A goal shall be scored if the puck has been deflected into the goal by a shot of an attacking player by striking any part of the person or a player of the same side. The player who deflected the puck shall be credited with the goal.
- f) Should a player legally propel a puck into the goal crease of the opponent's team and the puck should become loose and available to another player of the attacking side, a goal scored on the play shall be legal.
- g) The goal shall not be allowed if the puck has been kicked, thrown or otherwise deliberately directed into the goal by any means other than a stick.
- h) The goal shall not be allowed if an attacking player kicks the puck and it is deflected into the net by any player of either team.
- i) The goal shall not be allowed if scored as a result of a puck being deflected directly into the net from an official.
- j) The goal shall not be allowed if scored from a stick carried above the height of the cross bar of the goal cage, except by a player of the defending team.
- k) When a player charges a goalkeeper who is within the goal crease, subsequently makes physical contact with the goalie, and in the opinion of the Referee thus interferes with normal defence of the goal, any goal scored before or after such contact shall be disallowed and a Major Penalty and a Game Misconduct Penalty shall be assessed.
- l) Any goal scored other than as covered by the official rules shall not be allowed.

## 6 PENALTIES

### 6.1 Penalty Definition

#### 6.1.1 Penalty Categories

a) Penalties shall be actual playing time and shall be divided into the following classes:

- Minor Penalties
- Bench Minor Penalties
- Major Penalties
- Misconduct Penalties
- Game Misconduct Penalties
- Match Penalties
- Penalty Shot

#### 6.1.2 Minor Penalties

- a) For a Minor Penalty, any player, other than a goalkeeper, shall be ruled off the floor to the penalty box for two minutes during which time no substitute shall be permitted. For an exception, see Coincidental Penalty (6.2.3).
- b) A goalkeeper shall not be sent to the penalty bench for an offense which incurs a Minor Penalty, but instead, such penalty shall be served by a player who was on the floor at the time of the infraction. Such player shall be designated by the Manager or Coach through the Captain.
- c) If an injured player receives a Minor Penalty, the penalized team shall place a substitute player on the penalty bench before the penalty expires and no other replacement for the penalized player shall be permitted to enter the game except from the penalty bench. For violation of this rule a Bench Minor Penalty shall be imposed. The penalized player who has been replaced on the penalty bench shall not be eligible to play until that penalty has expired.
- d) A “Bench Minor” penalty requires the removal from the floor of one player of the team against which the penalty is awarded for a period of two minutes. When a Bench Minor Penalty is assessed and the player who is guilty of the infraction is identifiable, that player shall serve the penalty. However, if the player is not identified, any player on the floor at the time of the infraction may serve the penalty. Such player shall be designated by the Coach or Manager through the captain.

#### 6.1.3 Major Penalties

- a) For a Major Penalty, any player, including the goalkeeper, shall be ruled off the floor and be removed from the game. A substitute shall serve the five minute time penalty.
- b) Any player or goaltender incurring a Major Penalty shall be assessed a Game Misconduct Penalty.
- c) When coincidental Major and/or Match Penalties or coincident penalties of equal duration including a Major or a Match, being imposed against players on each team during the same stoppage of play, immediate substitutions shall be made for those penalties, and such penalties shall not be taken into account for the purpose of delayed (Stacked) penalties.
- d) When the coincidental Major/Match Penalty rule is applied and there is a differential in the total time penalties, those penalties causing the differential shall be served first in the normal manner and shall be taken into account for the purpose of applying Rule 6.1.1, Minor Penalties and Rule 6.2.2, Delayed Penalties. Any difference or differential in the total time penalties must be served by a player (or players) on the surface at the time of the infraction.

#### 6.1.4 Misconduct Penalties

- a) Misconduct Penalties to all players except the goalkeeper, involve removal from the game for a period of ten minutes each. A substitute player is permitted to immediately replace a player serving a misconduct penalty. A player whose Misconduct Penalty has expired shall remain in the penalty box until the next stoppage of play.

- b) Should a goalkeeper incur a Misconduct Penalty, this penalty shall be served by another team member who was on the floor when the offense was committed, this said player to be designated by the Manager or Coach of the offending team through the playing Captain.
- c) When a player receives a Minor Penalty and a Misconduct Penalty at the same time, the penalized team shall immediately put a substitute player on the penalty bench and the substitute shall serve the Minor Penalty without charge. The Misconduct Penalty will start when the Minor Penalty has ended.

#### 6.1.5 Game Misconduct Penalties

- a) A Game Misconduct Penalty involves the removal of a player for the balance of the game who shall be ordered to the dressing room for the remainder of the game, and shall be reported to IHNZ for further action (refer to Rule 8.2 Suspensions). The Coach or Manager of the penalized team, through the playing Captain, shall designate any player of his or her team on the surface at the time of the infraction to serve any time penalties associated with the Game Misconduct penalty.
- b) Should a goalkeeper incur a Game Misconduct penalty, the goalkeeper's place will be taken by a team member, or by a regular substitute goalkeeper who is available, and such player shall be allowed ten minutes to dress in the goalkeeper's full equipment.
- c) For all Game Misconduct Penalties regardless of when imposed, a total of ten minutes shall be charged in the records against the offending players.

NOTE: Tracking of Game Misconduct Penalties shall be the responsibility of the tournament organization and confirmed by the Inline Hockey Technical Commission.

#### 6.1.6 Match Penalties

- a) A Match Penalty involves the suspension of a player for the balance of the game, and the offender shall be ordered to the dressing room immediately. A substituted player must be placed on the penalty bench to serve a five minute penalty and may not return onto the floor regardless of goals scored.
- b) Should a goalkeeper incur a Match Penalty, the goalie's place will then be taken by a team member or by a substitute goalkeeper who is available, and such player will be allowed the goalkeeper's equipment. A ten minute time period shall be allowed for this change. However, any additional penalties as specifically called for by the individual rules covering match penalties will apply, and the offending team shall be penalized accordingly; such additional penalty to be served by another member of the team on the floor at the time the offense was committed, said player to be designated by the Manager or Coach of the offending team through the playing Captain.
- c) For all Match Penalties, regardless of when imposed, five minutes shall be charged in the records against the offending player.

#### 6.1.7 Additional Penalties

- a) On the third penalty assessed to any one player or goalkeeper in the same game, that player or goalkeeper will be assessed an additional ten minute Misconduct Penalty. (In addition to this applying to Minor Penalties or Coincidental Penalties, this also includes a delayed Minor Penalty that is washed out by the scoring of a goal).

NOTE: the penalised player will have a substitute player serve the time penalty and the penalized player will serve the entire penalty.

- b) Any subsequent penalty incurred within the game will result in that player being assessed a Game Ejection Penalty.
- c) Any player incurring three stick penalties within a single game will also be assessed a penalty appropriate to the last infraction and be assessed a Game Ejection Penalty. A substitute must serve any penalty time that the ejected player was assessed. Stick infractions are: slashing, high sticking, crosschecking, butt ending and spearing.



NOTE: A Game Ejection Penalty involves the removal of a player for the balance of the game. A substitute is permitted to replace the removed player immediately. A substitute must serve any penalty time that the ejected player was assessed.

- d) When any player or goalkeeper receives a second Misconduct Penalty in the same game that player or goalkeeper shall also be assessed an additional Game Misconduct Penalty.

#### 6.1.8 Penalty Shot

- a) A. When an infraction of the rules calls for a “Penalty Shot”, it shall be taken as follows:

Note: Five Criterion for calling of a Penalty Shot are:  
-The player fouled must have control of the puck  
-The puck must be over the centre line in the attacking zone  
-The player in control must have no other player to beat except the goalie  
-The player must be fouled from behind  
-The player must have been denied a reasonable scoring opportunity

- All players, except the player taking a penalty shot, must go to the player bench.
- If at the time a penalty shot is awarded and the goalkeeper of the penalized team has been removed from the floor to substitute another player, the goalkeeper shall be permitted to return to the floor before the penalty shot is taken.
- The Referee shall cause to be announced over the public address system the name of the player designated by the Referee or selected by the team (as appropriate) entitled to take the shot.
- In cases where a penalty shot has been awarded for illegal entry into the game, throwing a stick or fouling from behind, the Referee shall designate the player who has been fouled as the player who takes the penalty shot. In cases where a penalty shot has been awarded for falling on the puck in the crease or picking up the puck from the crease area, the penalty shot shall be taken by a player selected as the Captain of the non-offending team from the players on the floor at the time when the foul was committed.
- If by reason of injury the player designated by the Referee to take the penalty shot is unable to do so within a reasonable time, the shot may be taken by a player selected by the Captain of the non-offending team from the players on the floor when the foul was committed.
- Such selection shall be reported to the Lead Referee and cannot be changed.
- Should the player to whom a penalty shot has been awarded, also have committed a foul in connection with the same play or circumstances, either before or after the penalty has been awarded, and is designated to take the shot, the player shall first be permitted to do so before being sent to the penalty bench to serve the penalty.
- The Referee shall place the puck on the centre face-off spot and the player taking the shot will, on the whistle of the Referee, play the puck from there and shall attempt to score on the goalkeeper.
- The goalkeeper must stay in the crease until the Referee blows the whistle and the player taking the penalty shot touches the puck and crosses the centre line. The player taking the shot must keep the puck in motion towards the opponent’s goal line and once it is shot the play shall be considered complete. If the goalkeeper leaves the goal crease prior to the player touching the puck at centre and the player does not score on the penalty shot, the player will re-take the penalty shot.
- No goal can be scored on a rebound of any kind and any time the puck crosses the goal line the shot shall be considered complete. The goalkeeper may attempt to stop the shot in any manner except by throwing a stick or any other object, in which case a goal shall be awarded.

NOTE: A deflection of the goalkeeper resulting in the puck entering the net shall constitute a goal.

- b) If an opposing player other than the goalkeeper interferes with a player taking a penalty shot, a goal will be automatically awarded whether or not a goal was scored. The time required for the taking of a penalty shot will not be included in the regular playing time or any overtime.
- c) If a goal is scored from a penalty shot, the puck shall be faced at centre floor in the usual way. If a goal is not scored the puck shall be faced at either of the end face-off spots in the zone in which the penalty shot has been tried.
- d) If the offense for which the penalty shot was awarded was such as would normally incur a Minor Penalty, then regardless of whether the penalty shot results in a goal or not, no further Minor Penalty shall be served.
- e) Should a goal be scored from a penalty shot, a further penalty to the offending player shall not be applied unless the offense for which the penalty shot was awarded was such as to incur a Major or Match Penalty, in which case the penalty prescribed for the particular offense, shall be imposed.
- f) If the foul upon which the penalty shot is based, occurs during actual playing time, the penalty shot shall be awarded and taken immediately in the usual manner notwithstanding any delay occasioned by a slow whistle by the Referee. To permit the play to be completed which delays results in the expiration of the regular playing time in any period.
- g) For any assessment of a Penalty Shot, the infraction **MUST** be recorded on the Game Sheet. This will include the time of the penalty, the players name and number, penalty infraction (i.e. Tripping, Slashing and Hooking etc.).

## 6.2 Management of Penalties

### 6.2.1 Management of Penalty Situations

- a) Penalties shall not reduce the on-surface strength of the teams below three on-surface players (including the goalkeeper). Such penalties shall become delayed until such time as they can be served.
- b) If while a team is short-handed by one or more Minor or Bench Minor Penalties, the opposing team scores a goal, the first of such penalties shall automatically terminate.

NOTE: “Short-handed” means that the team must be below the numerical strength of its opponents on the floor at the time the goal is scored. The Minor or Bench Minor Penalty which terminates automatically when the team is scored against is the one which initially caused the team to be “shorthanded” (first penalty). However, Coincidental Minor Penalties to both teams do NOT cause either side to be “short-handed”, because although each team has a player in the penalty box, the number of floor players is not affected. Therefore, the penalty time awarded for Coincidental Penalties is never shortened by a goal being scored. This rule shall also apply when a goal is scored on a penalty shot, which was awarded in lieu of another penalty.

- c) When a player receives a Major Penalty and a Minor Penalty at the same time, the Major Penalty shall be served first by the substitute for the penalised player except under Rule 6.2.2 in which case the Minor Penalty will be recorded and served first.

NOTE: This applies to the case where BOTH penalties are imposed on the SAME player (See also note to Rule 6.2.2c).

### 6.2.2 Delayed Penalties

- d) If a third player of any team shall be penalised while two players of the same team are serving penalties, the penalty time of the third player shall not commence until the penalty time of one of the two players already penalised shall have elapsed. Nevertheless, the third player penalised must at once, proceed to the penalty bench but may be replaced by a substitute until such time as the penalty time of the penalized player shall commence.
- e) When any team shall have three players serving penalties at the same time and because of the delayed penalty rule, a substitute for the third offender is on the floor, none of the three penalised players on the penalty bench may return to the floor until play has been stopped. When the play has been stopped, the player whose full penalty has expired may return to the

playing surface. However, the Penalty Timekeeper shall permit the return to the floor in the order of expiration of their penalties, of a player or players by reason of the expiration of their penalties and, the penalised team is entitled to have more than four players on the floor.

- f) In the case of Delayed Penalties, the Referee shall instruct the Penalty Timekeeper that penalised players whose penalties have expired shall only be allowed to return to the floor when there is a stoppage of play. When the penalties of two players of the same team will expire at the same time the Captain of that team will designate to the Referee which of such players will return to the floor first, and the Referee will instruct the Penalty Timekeeper accordingly. When a Major and a Minor Penalty are imposed at the same time on players of the same team the Penalty Timekeeper will record the minor as being the first of such penalties.

NOTE: This applies to the case where the two penalties are imposed on DIFFERENT players of the same team.

- g) When a Delayed Penalty is in the process of being assessed to a team that is already shorthanded because of a previous Minor or a Bench Minor Penalty, and the non-offending team scores a goal, the original penalty is terminated which caused the offending team to be short a player and the new penalty is assessed to the offending team, which plays again shorthanded.

### 6.2.3 Coincidental Penalties

- a) Coincidental Minor/Major Penalties are penalties that do not cause either team to be shorthanded (i.e. 4 on 4 or 3 on 3) and occurs when player(s) from both teams simultaneously receive equal length penalties. When Coincidental Penalties are assessed, the penalised players take their places on their respective penalty benches. Both teams are able to make immediate substitutions for these penalised players.
- b) The penalised players are required to serve the full amount of assessed time and must remain in the penalty box until the first stoppage of play after the expiration of time.
- c) If one team is already short a player because of an earlier penalty, Coincidental Penalties will not change the number of players on the floor.

### 6.3 Calling of Penalties

- a) Should an infraction of the rules which would call for a Minor, Major, Misconduct or Match penalty be committed by a player of the side in possession of the puck, the Referee shall immediately blow a whistle and give the penalties to the deserving players. The resulting face-off shall be made at one of the end zone face-off spots of the offending team.
- b) Should an infraction of the rules which call for a Minor, Major, Misconduct, or Match Penalty be committed by a player of the team not in possession of the puck, the Referee shall signify the calling of a Delayed Penalty by using a raised right arm straight above the head and, on completion of the play by the team in possession or the loss of possession to the defending team, the Referee will immediately blow a whistle and assess the penalty to the offending player. The resulting face-off shall be made at one of the end zone face-off spots of the offending team.
- c) If the penalty to be imposed is a Minor Penalty, and a goal is scored on the play by the non-offending team the Minor Penalty shall not be imposed, but Major and Match Penalties shall be imposed in the normal manner regardless of whether a goal is scored or not. (The penalty shall be recorded by the scorekeeper).

NOTE: "Completion of the play by the team in possession". This rule means that the puck must have come into the possession and control of an opposing player or has been "frozen". This does not mean a rebound off the goalkeeper, the goal cage or any accidental contact with the body or equipment of an opposing player.

- d) If after the Referee has signalled a penalty but before the whistle has been blown the puck shall enter the goal of the non-offending team as the direct result of the action of a player of that team, the goal shall be allowed and the penalty signalled shall be imposed in the normal manner.
- e) If when a team is "short-handed" by reason of one or more Minor or Bench Minor Penalties, the Referee signals a further Minor Penalty against the "short-handed" team and a goal is scored by the non-offending side before the whistle is blown, then the delayed penalty shall be served

and the first of the Minor Penalties already being served shall automatically terminate under Rule 6.2.1.

- f) Should the same offending player commit other fouls on the same play either before or after the Referee has blown a whistle, the offending player shall serve such penalties consecutively. If a team has a Delayed Minor Penalty and that team is scored upon during the delayed penalty, the penalty shall not be assessed, but it shall be recorded on the Official Score Sheet and count in the offending player's penalty total. If the Delayed Penalty is Major, then that penalty will be assessed.

## **6.4 Implementation of Penalties**

### **6.4.1 General**

- a) When an offense is committed by any player or goalkeeper during the play or at a stoppage of play the same penalty shall apply.
- b) Players may not leave the penalty bench until their penalty has expired. When directed by the referee, players may leave the penalty bench at half time or may leave at the end of the game. The player may not leave for any other reason. Any overtime period shall be considered part of the game and all unexpired penalties shall remain in force. All players in the penalty bench must remain seated until the penalty time is expired.
- c) When a penalised player's time has expired or been terminated by the scoring of a goal, that player must return to the surface prior to being substituted.
- d) When Coincidental Minor Penalties are imposed against an equal number of players on each team, the penalised players shall all take their places on the penalty benches and such penalised players shall not leave the penalty bench until the first stoppage of play following the expiration of their respective penalties. Immediate substitutions shall be made for the players so penalised, and their penalties shall not be taken into account for the purpose of the Delayed Penalty, Rule 6.3.
- e) When Coincidental Penalties of equal duration (Minor/Bench Minor) are imposed upon a player of each team, the penalised players shall take their places on the penalty bench and such players shall not leave the penalty bench until the first stoppage of play following the expiration of their respective penalties. Immediate substitution shall be made for the players so penalised and their penalties shall not be taken into account for the purpose of the delayed penalty, Rule 6.2.2 or Rule 6.1.4.

### **6.4.2 Protest**

- a) A complaint about a Penalty is not a matter relating to the "Interpretation of the Rules" and a Misconduct Penalty shall be imposed against any Captain, Alternate Captain or other players making such a complaint.
- b) A Misconduct Penalty must be imposed on any Captain, Alternate Captain or player who comes off the bench and makes any protest or intervention with the Referee for any purpose.

### **6.4.3 Illegal Equipment**

- a) A Minor Penalty shall be imposed on any player, including the goalkeeper, for using a stick which does not conform to the provisions of Rule 3.2.2.
- b) A Minor Penalty shall be imposed on any player taking the surface wearing skates which does not conform to the provisions of Rule 3.2.3. The player may not return to play until the fault is corrected.
- c) A Minor Penalty shall be imposed on any player wearing illegal protective equipment according to Rule 3.2.4.
- d) A Minor Penalty shall be assessed a goalkeeper guilty of using or wearing illegal equipment.
- e) If a goalkeeper's helmet comes off during the play the Referee shall stop play immediately. No penalty shall be assessed unless the Referee determines that the goalkeeper deliberately took their helmet off to stop the play. A Minor Penalty shall be assessed unless the criteria for a Penalty Shot shall be met. If any other goalkeepers' equipment shall come off during the play the Referee shall allow the play to continue.

- f) A Minor Penalty shall be imposed, after one warning by the Referee, on any player for violation of provisions of Rule 3.2.7 related to protective equipment.

#### **6.4.4 Face Offs**

- a) A Minor Penalty or Penalties shall be imposed on the player(s) whose action(s) caused the physical contact during a face-off.
- b) A Minor Penalty for Delay of Game shall be imposed to the player who commits a second violation of any of the provisions or sub-selection(s) of Rule 5.5.1 during the same face-off.

#### **6.4.5 Adjustment to Clothing and Equipment**

- a) A Minor Penalty for Delay of the Game shall be imposed on any player or goalkeeper for violation of provisions of Rule 5.5.3 related to adjustment to clothing and equipment.

NOTE: In the event a player loses a helmet in the “process of a play”, such player shall replace the helmet (properly fastened) or shall proceed to the players’ bench for a substitution. If such player participates in play, the play must be stopped immediately and a Minor Penalty shall be assessed.

NOTE: However a goalkeeper, after a stoppage of play, with the permission of the Referee, may be allowed to make adjustments or repairs to clothing, equipment or skates. Goalkeepers may also be permitted by the Referee to replace their goalie mask but no time shall be allowed for repair or fitting a mask.

#### **6.4.6 Change of Players**

- a) A Bench Minor Penalty shall be assessed for violation of any section of Rule 5.5.4. The penalty shall be served by that player who committed the infraction.
- b) If in the course of making a substitution, either the player entering the game or leaving the game intentionally plays the puck with their stick, skates or hands or makes physical contact with an opposing player while the player (either leaving or entering the game) is actually on the surface, then a Bench Minor Penalty for “too many players” on the surface” shall be assessed. However, in the course of leaving or entering the game, the player is accidentally struck by the puck, no penalty shall be assessed and play shall not be stopped.
- c) If in the last two minutes of regular playing time or any overtime a Bench Minor Penalty is imposed for deliberate illegal substitution by the defending team, which provided them more men on the floor, a Penalty Shot shall be awarded to the non-offending team. The Bench Minor Penalty shall not be served.

#### **6.4.7 Goalkeeper Penalties**

- a) A Minor Penalty shall be imposed on a goalkeeper who participates in the play in any manner, when the goalie is beyond the centre line.
- b) A Minor Penalty shall be imposed on a goalkeeper who (when the goalkeeper’s body is entirely outside the privileged area, or the boundaries of the goal crease area when the puck is behind the goal line) deliberately falls on or gathers the puck to the body or who holds or places the puck against the boards.
- c) A Minor Penalty shall be imposed on a goalkeeper who holds the puck with the hands for longer than three seconds, if there are no attacking players in the immediate vicinity.
- d) A goalkeeper shall not deliberately hold the puck in any manner which in the opinion of the Referee causes a stoppage of play, nor deliberately drop the puck into the goalie pads or onto the goal net, nor deliberately pile up obstacles at or near the net, that in the opinion of the Referee would tend to prevent the scoring of a goal.

NOTE: The object of the entire rule is to keep the puck moving continuously and any action taken by the goalkeeper who causes an unnecessary stoppage must be penalized without warning.

NOTE: In the case of a puck thrown forward by the goalkeeper being taken by an opponent, the Referee shall allow the resulting play to be completed. However, should the throw be received by a teammate, the play shall be stopped for a forward hand pass by the goalkeeper with a face-off to be taken at the end zone face-off circle. The goalkeeper shall be permitted to roll the puck to a player of his team providing the puck is rolled outside the privileged area or behind his goal line to the side of the goal cage.

- e) A Minor Penalty shall be imposed on a goalkeeper who deliberately drops the puck on the goal netting to cause a stoppage of play.
- f) A Game Misconduct Penalty shall be imposed on a goalkeeper who leaves the immediate vicinity of the goal crease and takes part in any altercation.

NOTE: All penalties imposed on a goalkeeper regardless of who serves the penalty or any substitution, shall be charged in the records against the goalkeeper.

#### 6.4.8 Displacement of the Goal Post

- a) A Minor Penalty for Delay of the Game shall be imposed on any player (including goalkeeper) who delays the game by deliberately displacing a goal post from the normal position.
- b) If the action of Rule 6.4.8a occurs in the last two minutes of regular playing time or overtime a Penalty Shot shall be awarded against the non-offending team.

#### 6.4.9 Abuse of Officials and Other Misconduct

- a) A Minor or Misconduct Penalty, at the discretion of the Referee, may be assessed for Abuse of Officials or other Misconduct.

NOTE: In the enforcement of this rule the Referee has, in many instances, the option of imposing a "Minor Penalty", "Misconduct Penalty" or a "Bench Minor Penalty". In principle the Referee is directed to impose a "Bench Minor Penalty" in respect to the violations which occur on or in the immediate vicinity of the player bench but also off the playing surface, and in all cases affecting non-playing personnel or players.

NOTE: A Minor or Misconduct Penalty may be imposed for violations which occur on the playing surface. A Misconduct Penalty should be imposed for violations which occur on the playing surface or in the penalty bench area and where the penalised player is readily identifiable.

- b) A Misconduct Penalty shall be imposed on any player who intentionally knocks or shoots the puck out of the reach of a Referee who is retrieving it.
- c) A Misconduct Penalty shall be imposed on players who bang the boards or goal cage with their sticks or any other equipment at any time.
- d) A Misconduct Penalty shall be imposed on penalised players who do not proceed directly and immediately to the penalty bench and take the required place on the penalty bench. Any player who (following a fight or other altercation in which the player has been involved is broken up, and for which the player is penalised) fails to proceed immediately to the penalty bench or who persists in continuing or attempting to continue the fight or altercation or who resists a Referee in the discharge of the Referee's duties shall incur a Game Misconduct Penalty.
- e) A Game Misconduct Penalty shall be imposed on any player who, after warning by the Referee, persists in any course of conduct (including threatening or abusive language or gestures or similar actions) designed to incite an opponent into incurring a penalty.
- f) In the case of any Club Official, Manager, Coach or Team Official being guilty of such Misconduct, that person is to be removed from the building and this incident reported IHNZ.
- g) If any Manager, Coach or Team Official is removed from the bench by order of the Referee, that person must not sit near the team bench, nor in any way direct or attempt to direct the play of this team.

- h) A Misconduct Penalty shall be imposed against any player using obscene, profane or abusive language to any person or any Game Official.
- i) A Game Misconduct Penalty shall be imposed against the offending team if any player, Manager, Coach or Team Official in the vicinity of the player bench or penalty bench throws anything on the floor during the progress of the game or during stoppage of play.
- j) A Game Misconduct Penalty shall be imposed against the offending team if any player, Manager, Coach or Team Official interferes in any manner with any Game Official. This consists of the Referee's, Official Scorer, Game Timekeeper, Penalty Timekeeper or Goal Judge in the performance of their duties.

NOTE: The Referee may assess further penalties under this rule if deemed warranted.

- k) A Misconduct Penalty shall be imposed on any player or players who, except for the purpose of taking their positions on the penalty bench, enter or remain in the Referees Crease while the Referee is reporting to, or consulting with any Game Official including Official Scorer, Game Timekeeper, Penalty Timekeeper or Announcer.
- l) A Minor Penalty/Bench Minor Penalty shall be assessed to any player or Team Official who challenges or disputes the rulings of any Game Official during the game or who displays unsportsmanlike conduct. If a player or goaltender persists, he/she shall be assessed a Misconduct Penalty and any further disputes will result in a Game Misconduct Penalty being assessed to the offending player or goaltender. If a Team Official persists, after he/she has been assessed a Bench Minor Penalty he/she shall be immediately assessed a Game Misconduct Penalty. A Referee is not required to assess a Minor Penalty under this rule before assessing the Misconduct or Game Misconduct but may assess either of these penalties initially.

NOTE: If continued actions by a player already having been assessed a penalty for unsportsmanlike conduct the Referee may assess a Match Penalty. The Match Penalty shall be assessed for making a travesty of the situation or bring the game into disrepute.

#### **6.4.10 Attempt to Injure**

- a) A Match Penalty shall be imposed on any player who deliberately attempts to injure an opponent, Game Official, Manager, Coach or Team Official in any manner. The circumstances shall be reported to IHNZ for further action. A substitute for the penalized player shall be permitted at the end of the fifth minute.

#### **6.4.11 Broken Stick**

- b) A player or goalkeeper whose stick is broken may participate in the game provided the player immediately drops this stick. A Minor Penalty shall be imposed for an infraction of this rule.
- c) A player or goalkeeper whose stick is broken may not receive a stick thrown on the floor from any part of the rink, but must obtain one from the player bench. A Minor Penalty shall be imposed on the player or goalkeeper receiving a stick illegally under this rule. The player who threw the object onto the surface shall also be assessed a Minor Penalty plus an automatic Game Misconduct. If the player is not identified, then a Bench Minor penalty shall be assessed.
- d) A goalkeeper may not continue to play with the paddle portion of a broken stick.

NOTE: A broken stick is one which, in the opinion of the Referee, is unfit for normal play.

#### **6.4.12 Charging**

- a) A Minor Penalty or a Major Penalty and a Game Misconduct Penalty at the discretion of the Referee shall be imposed on a player who runs or jumps into or charges an opponent.
- b) A Major Penalty and a Game Misconduct Penalty shall be imposed on a player who charges a goalkeeper while the goalkeeper is within the goal crease. If the charging player makes physical contact with the goal keeper, which in the opinion of the Referee interferes with normal defence of the goal, any goal scored before or after such contact shall be disallowed.

NOTE: A goalkeeper is NOT “fair game”. just because the goalkeeper is outside the goal crease area. A penalty for interference or charging (Minor or Major plus Game Misconduct) should be called in every case where an opposing player makes unnecessary contact with a goalkeeper.

#### 6.4.13 Boarding

- a) A Minor Penalty or at the discretion of the Referee, a Major Penalty and a Game Misconduct Penalty based upon the degree of violence of the impact with the boards, shall be imposed on any player who body checks, cross checks, elbows, charges or trips an opponent in such a manner that causes the opponent to be thrown violently into the boards.

NOTE: Any unnecessary contact with a player carrying the puck which results in that player being knocked into the side boards is “boarding” and must be penalized as such. In other instances where there is no contact with the boards it should be treated as “charging”.

NOTE: “Rolling” an opponent (if that player is the puck carrier) along the boards where the player is endeavouring to go through too small an opening is not boarding. However, if the opponent is not the puck carrier, then such action should be penalized as boarding, charging, interference, or if the arms or stick are employed it should be called holding or hooking.

#### 6.4.14 Cross Checking

- a) A Minor Penalty or at the discretion of the Referee, a Major Penalty and a Game Misconduct Penalty shall be imposed on a player who cross checks an opponent.
- b) A Major Penalty and a Game Misconduct Penalty shall be imposed on a player who cross checks a goalkeeper while the goalkeeper is within the goal crease.
- c) A Major Penalty and a Game Misconduct Penalty shall be imposed on any player who injures an opponent by cross checking.

NOTE: Cross check shall mean a check delivered with both hands on the stick and no part of the stick on the floor.

#### 6.4.15 Deliberate Injury to Opponents

- a) A Match Penalty shall be imposed on a player who deliberately injures an opponent in any manner.
- b) No substitute shall be permitted to take the place of the penalized player until five minutes actual playing time shall have elapsed, from the time the penalty was imposed.
- c) A Match penalty shall be assessed any player guilty of kicking or attempting to kick any part of an opponent’s body or skates.

NOTE: All such instances shall be reported to IHNZ.

#### 6.4.16 Delaying the Game

- a) No player or goalkeeper shall delay the game by deliberately shooting or batting the puck outside the playing area. A Minor Penalty shall be imposed immediately and without warning, against any player or goalkeeper who throws the puck outside the playing area.
- b) A Bench Minor Penalty shall be imposed upon any team which, after warning by the Referee to its Captain or Alternate Captain to place the correct number of players on the floor and commence play, fails to comply with the Referee’s direction and thereby causes any delay by making additional substitution or in any other manner.



#### 6.4.17 Elbowing and Kneeing

- a) A Minor Penalty or at the discretion of the Referee, a Major Penalty and a Game Misconduct Penalty shall be imposed on any player who uses an elbow or knee in such a manner as to in any way foul an opponent.
- b) A Major Penalty and a Game Misconduct Penalty shall be imposed on any player who injures an opponent as the result of a foul committed by using elbows or knees.

#### 6.4.18 Falling on the Puck

- a) A Minor Penalty shall be imposed on a player other than the goalkeeper who deliberately falls on or gathers a puck into the body.

NOTE: Defensemen who drop to their knees to block shots should not be penalised if the puck is shot under them or becomes lodged in their clothing or equipment but any use of the hands to make the puck unplayable should be penalised promptly.

- b) No defending player except the goalkeeper will be permitted to fall on the puck or hold the puck or gather the puck into the body or hands when the puck is within the goal crease. The resulting penalty shall be a Penalty Shot being awarded to the non-offending team. If the goalkeeper has been legally substituted the Penalty Shot shall not be taken but the non-offending team shall be awarded a goal.

#### 6.4.19 Fighting

- a) Fighting is defined as the actual throwing of a punch(es) with a closed fist by a player who makes actual contact with an opponent.

NOTE: Pushing, shoving or grappling while on skates are punishable offenses, but do not constitute fighting under this rule.

- b) A Major Penalty and a Game Misconduct Penalty shall be imposed on any player who starts fighting.
- c) A Minor Penalty shall be imposed on a player who having been struck shall retaliate with a blow or attempted blow. However, at the discretion of the Referee, a Major or Double Minor Penalty may be imposed if that player continues the altercation.

NOTE: The Referee is provided very wide latitude in the penalties which the Referee may impose under this rule. This is done intentionally to enable the Referee to differentiate between the obvious degrees of responsibility of the participants either for starting the fighting or persisting in continuing the fighting. The discretion provided should be exercised realistically.

NOTE: Referees are directed to employ every means provided by these rules to stop "brawling" and should use Rule 6.4.9 for this purpose unless the coincidental Major Penalty rule is involved.

- d) A Game Misconduct Penalty shall be imposed on any player involved in fighting off the playing surface or with another player who is off the playing surface.
- e) A Game Misconduct penalty shall be imposed on any player or goalkeeper on the floor who first intervenes in an altercation then in progress.

Note: To apply Rule 6.4.19e, one player must be assessed a Major Penalty and a Game Misconduct.

- f) A Match Penalty in addition to any other penalties incurred shall be imposed on any player who intentionally removes their helmet to fight.

NOTE: If the suspended player's team draws a bye for their next game, this penalty will be carried over to the next game that the team plays.

NOTE: The penalised team will place a player in the penalty bench and play short-handed for the duration of the Major Penalty.

- g) An additional Match Penalty shall be imposed on any player involved in a fight wearing a ring or having their hands taped in such a manner to gain an advantage or cause injury.
- h) Any player assessed a Major Penalty and a Game Misconduct Penalty for fighting will be automatically removed from the balance of that game and be suspended for the next game his or her team plays unless otherwise stated in the playing rules.

#### 6.4.20 Handling Puck with Hand

- a) A Minor Penalty shall be imposed on a player, except the goalkeeper, who closes the hand or glove intentionally on the puck, and the play shall be stopped.
- b) A Minor Penalty shall be imposed on a player, except the goalkeeper who, while play is in progress, picks up the puck by hand from the floor.
- c) A player shall be permitted to stop or “bat” a puck in the air with an open hand, or push it along the floor by hand, and the play shall not be stopped unless in the opinion of the Referee the player has deliberately directed the puck to a teammate, in which case the play shall be stopped and the puck faced-off at the spot where the offense occurred.
- d) A goalkeeper is permitted to “roll” the puck out to the side and not directly towards the opposing team goal. The goalkeeper may roll the puck to a player of his team without the Referee stopping the play for a hand pass.
- e) For a violation of a hand pass in the attacking zone the face off shall take place at the centre spot. If the violation occurred in the defending zone the face off shall take place at the end-zone face-off circle on the side the pass originated.

NOTE: The object of this rule is to ensure continuous action and the Referee should NOT stop play unless the Referee is satisfied that the directing of the puck to a teammate was in fact deliberate. The puck may not be batted with the hand directly or indirectly as into the net at any time. If the last play on the puck was with the hand and the puck is deflected into the net the goal shall not count. The exception to the rule is when the act is done by the defending team in which case the goal shall be allowed.

#### 6.4.21 High Sticks

- a) The carrying of the blade of the stick above the normal height of the shoulders is prohibited.
- b) Using the stick to bat the puck above the normal height of the shoulders is prohibited and when it occurs there shall be a whistle and ensuing face-off at the spot where the offense occurred unless:
  - The defending player batted the puck to an opponent in which case the play shall continue, or
  - A player of the defending side batted the puck into his or her own goal in which case the goal shall be allowed.
- c) When a stick is swung above the shoulders at a puck near another player, that player shall be called for high sticking and a Minor Penalty imposed on.

EXCEPTION: No penalty should be assessed when the stick is shifted from one hand to the other over the head so the player can play the puck, unless it endangers another player.

NOTE: At the beginning and ending of a slap shot, the blade may be above shoulder level.

NOTE: No contact on an opponent need occur to call a High Sticking Penalty, however an opposing player must be in the immediate vicinity to justify a penalty being called.

- d) A Minor Penalty or at the discretion of the Referee, a Major Penalty and a Game Misconduct penalty, shall be imposed on any player who makes contact with or intimidates an opponent while carrying the stick blade above the shoulders of an opponent. If injury results, a Major Penalty and a Game Misconduct Penalty shall be imposed.
- e) When a player carries or holds any part of the stick above the height of the shoulders so that injury to the face or head of an opposing player results, the Referee shall have no alternative but to impose a Major Penalty and a Game Misconduct Penalty on the offending player.
- f) When either team is below the numerical strength of its opponent and a player of the team of greater numerical strength causes a stoppage of play by striking the puck with the stick above the height of the shoulders, the resulting face-off shall be made at one of the end face-off spots adjacent to the goal of the team causing the stoppage.

#### 6.4.22 Holding

- a) A Minor Penalty or at the discretion of the Referee, a Major Penalty and a Game Misconduct Penalty shall be imposed on a player who holds an opponent with hands, legs, feet or stick or in any other way.
- b) A Major Penalty and a Game Misconduct Penalty shall be imposed if the action of holding, results in injury to the player being held.

#### 6.4.23 Hooking

- a) A Minor Penalty or at the discretion of the Referee, a Major Penalty and a Game Misconduct Penalty shall be imposed on a player who impedes or seeks to impede the progress of an opponent by hooking with either end of that player's hockey stick.
- b) A Major Penalty and a Game Misconduct Penalty shall be imposed on any player who injures an opponent by hooking.

NOTE: When a player is checking another in such a way that there is only stick-to-stick contact, such action is NOT either hooking or holding. That player may turn the stick down over the opponent's stick.

#### 6.4.24 Interference

- a) A Minor Penalty or at the discretion of the Referee, a Major Penalty and a Game Misconduct Penalty shall be imposed on a player who interferes with or impedes the progress of an opponent, who is not in possession of the puck, or who deliberately knocks a stick out of an opponent's hand or who prevents a player who has dropped a stick from regaining possession of it or who knocks or shoots any abandoned or broken stick or illegal puck or other debris towards an opposing puck carrier in a manner that could cause that player to be distracted.

NOTE: The last player to touch the puck, other than a goalkeeper, shall be considered the player in possession. In interpreting this rule the Referee should make sure which of the players is the one creating the interference. Often it is the action and movement of the attacking player which causes the interference since the defending players are entitled to "stand their ground" or "shadow" the attacking players. Players of the side in possession shall not be allowed to "run" deliberate interference for the puck carrier

- b) A Minor Penalty and a Game Misconduct Penalty shall be imposed if any player on the player bench or on the penalty bench who interferes with the movement of the puck or of any opponent on the floor during the progress of play.
- c) A Minor Penalty shall be imposed on a player who, by means of a hockey stick or body, interferes with or impedes the movements of the goalkeeper by actual physical contact, while the goalie is in the crease area unless the puck is already in that area.
- d) Unless the puck is in the goal crease area, a player of the attacking side not in possession may not stand on the goal crease line or in the goal crease or hold a stick in the goal crease area, and if the puck should enter the net while such a condition prevails, a goal shall not be allowed. The puck shall be faced off at the centre face-off spot.

- e) If a player of the attacking side has been physically interfered with by the action of any defending player so as to cause that player to be in the goal crease, and the puck should enter the net while the player so interfered with, is still within the goal crease, the goal shall be allowed.
- f) If when the goalkeeper has been removed from the floor any member of the same team not legally on the floor including the Manager, Coach or Team Official interferes by means of body or stick or any other object with the movement of the puck or an opposing player, the Referee shall immediately award a goal to the non-offending team.

NOTE: A penalty for interference should be called in every case where an opposing player makes unnecessary contact with the player not in possession.

NOTE: The attention of the Referees is directed particularly to three types of offensive interference which should be penalized:

- When the defending team secures possession of the puck in its own end and the other players of that team run interference for the puck carrier by forming a protective screen against fore-checkers.
- When a player facing-off obstructs the player's opposite number after the face-off when the opponent is not in possession of the puck.
- When the puck carrier makes a drop pass and follows through so as to make bodily contact with an opposing player.

NOTE: All offensive or defensive players may attempt to establish positional territory in front of either goal. The incidental contact that occurs in so doing shall not be considered interference or unnecessary roughness. However, should a player from either team run at an opponent, or make a body check, it is at the discretion of the Referee, to assess a Minor Penalty for interference, charging or unnecessary roughness.

#### 6.4.25 Interference by Spectators

- a) In the event of a player being held or interfered with by a spectator, the Referee shall blow the whistle and play shall be stopped, unless the team of the player interfered with is in possession of the puck at the time, then the play shall be allowed to be completed before blowing the whistle, and the puck shall be faced-off at the spot where last played at the stoppage.

NOTE: The Referee shall report to IHNZ for possible disciplinary action, all cases in which a player becomes involved in an altercation with a spectator whether a penalty has been imposed or not. In the event that objects are thrown on the floor which interfere with the progress of the game the Referee shall blow the whistle and stop the play, and a face-off shall occur at the spot the play is stopped.

#### 6.4.26 Checking From Behind

- a) A Major Penalty and a Game Misconduct Penalty shall be imposed on any player who intentionally pushes, body-checks or hits an opposing player from behind, anywhere on the skating surface.
- b) Where a player is high-sticked, cross-checked, body-checked, hit or propelled in any manner from behind into the boards or goal cage in such a way that the player is unable to defend him or herself, a Match Penalty shall be imposed on the offending player.

NOTE: Referees are instructed not to substitute other penalties when a player is checked from behind in any manner. This rule must be strictly enforced.

#### **6.4.27 Leaving the Player or Penalty Benches**

- a) No player may at any time leave the penalty bench, except at the end of each period, or on expiration or termination of their penalty.
- b) A penalised player who leaves the penalty bench before the player's penalty has expired, whether play is in progress or not, shall incur an additional Minor Penalty, after serving the player's unexpired time.
- c) If a player leaves the penalty bench before the player's penalty is fully served, the Penalty Timekeeper shall note the time and report the incident to the referee at the next stoppage in play. In the case of a player returning to the floor before the player's time has expired through an error by the Penalty Timekeeper, that player is not to serve an additional penalty, but must serve the player's unexpired time.
- d) If a penalised player returns to the floor from the penalty bench before the player's penalty has expired by the player's own error or the error of the Penalty Timekeeper, any goal scored by the player's own team while that player is illegally on the floor shall be disallowed, but all penalties imposed on either team shall be served as regular penalties.
- e) No player may leave the player bench or penalty bench at any time to enter an altercation. Substitutions made prior to the altercation shall be permitted provided the players so substituting do not enter the altercation.
- f) For a violation of this rule a Double Minor Penalty and a Game Misconduct shall be imposed on the player of the team who was the first to leave the player or penalty bench during an altercation.
- g) If players of both teams leave their respective benches at the same time, the first identifiable player from each team to do so shall incur a Double Minor Penalty. A Game Misconduct penalty shall also be imposed on any player penalized under this section, plus any other penalties they may incur.
- h) Any penalised player leaving the penalty bench during the stoppage of play, and entering an altercation shall incur a Minor Penalty and a Game Misconduct Penalty, after serving the player's unexpired time.
- i) If a player illegally enters the game from the player's own player bench, any goal scored by the player's own team while that player is illegally on the floor shall be disallowed, but all penalties imposed against either team shall be served as regular penalties.

#### **6.4.28 Physical Abuse of Officials**

- a) Any player who touches or holds a Referee, or any Game Official, with the player's hand or stick or trips or body checks any such Officials, shall automatically receive a Match Penalty. The use of a substitute for the player so suspended shall be permitted.
- b) A Match Penalty shall be imposed on any Manager, Coach or Team Official who holds or strikes an official.

#### **6.4.29 Obscene or Profane Language or Gestures**

- a) A Game Misconduct penalty shall be assessed on any player, Manager, Coach and Team Official:
  - Who uses obscene or profane language or gestures to any person on the floor or anywhere in the rink, including travesty of the game and discriminatory slur or racial remarks;
  - Who persists in disputing or shows disrespect for the ruling of any Official during a game;
  - Who brings the game into disrepute.

NOTE: It is the responsibility of all Game Officials and all Team Officials to send a confidential report to IHNZ setting out the full details concerning the use of obscene gestures by any player, Coach or Team Official. IHNZ shall take further disciplinary action as deemed appropriate.

#### **6.4.30 Slashing**

- a) A Minor Penalty or at the discretion of the Referee, a Major Penalty and a Game Misconduct Penalty shall be imposed on any player who impedes or seeks to impede the progress of an

opponent by “slashing” with the player’s stick. Any stick to body contact enacted by the pursuing player will be considered slashing.

- b) A Major Penalty and a Game Misconduct Penalty shall be imposed on any player who injures an opponent by slashing.

NOTE: Referees should penalise as slashing any player who swings the player’s stick at any opposing player (whether in or out of range) without actually striking that player or where a player on the pretext of playing the puck makes a wild swing at the puck with the object of intimidating an opponent.

- c) Any player who swings the player’s stick at another player in the course of any altercation shall be assessed a match penalty. This is considered a deliberate attempt to injure.
- d) Any player not in possession of the puck cannot have any stick contact upon the goalkeeper or it will be considered a slashing penalty.

NOTE: The Referee shall impose the normal appropriate penalty provided in the other sections of this rule and shall in addition report promptly to IHNZ all infractions under this section.

#### 6.4.31 Spearing and Butt-Ending

- a) A Double Minor Penalty shall be imposed on a player who spears or attempts to spear or butt-ends or attempts to butt-end an opponent.
- b) A Match Penalty shall be imposed on any player who injures an opponent by spearing or butt-ending. This should be treated as a deliberate attempt to injure under Rule 6.4.15.

NOTE: “Spearing” shall mean stabbing an opponent with the point of the stick blade while the stick is being carried with one hand or with both hands. “Butt-ending” shall mean stabbing an opponent with the butt-end of the stick while the stick is being carried with one hand or with both hands.

NOTE: “Attempt to spear” shall include all cases where a spearing gesture is made regardless of whether bodily contact is made or not.

#### 6.4.32 Throwing Stick

- a) A Bench Minor and a Game Misconduct Penalty shall be imposed on any player or Team Official who throws a stick or any other object onto the playing surface from the player bench or penalty bench. If the player is not identified, then a Bench Minor shall be imposed.
- b) A Major Penalty and a Game Misconduct Penalty shall be imposed on any player on the surface who throws the player’s stick, of any part thereof or any other object, in any area except when such an act has been penalised by the award of a Penalty Shot on goal.
- c) If, when the opposing goalkeeper has been removed from the floor (i.e. legally substituted) and the attacking player has no defending player to pass and has a chance to score on an open net, a goal shall be awarded to the attacking side.

NOTE: When a player discards the broken portion of a stick by throwing it to the side of the floor (and not over the boards) in such a way that it will not interfere with play or opposing player, no penalty will be imposed. The Referee shall report promptly to IHNZ for disciplinary action every case where a stick or any part thereof is thrown outside the playing area.

#### 6.4.33 Tripping

- a) A Minor Penalty or at the discretion of the Referee, a Major Penalty and a Game Misconduct Penalty shall be imposed on any player who shall place the player’s stick, knee, foot, arm, hand or elbow in such a manner that shall cause the player’s opponent to trip or fall.

NOTE: If in the opinion of the Referee, a player is unquestionably hook-checking the puck and obtains possession of it thereby tripping the puck carrier, no penalty shall be imposed.

- b) A Major Penalty and a Game Misconduct Penalty shall be assessed to any player who shall place the player's stick, knee, foot, arm, hand or elbow in such a manner that shall cause the player's opponent to trip or fall and be injured.

#### 6.4.34 Roughing

- a) A Minor Penalty or at the discretion of the Referee, a Major Penalty and a Game Misconduct Penalty may be imposed on any player deemed guilty of roughing.
- b) A Major Penalty and a Game Misconduct Penalty shall be imposed on if the action of roughing results in an injury to the player being roughed.

NOTE: It is not intended that there be no body contact between two opposing players who are actively in pursuit of the puck. The act of riding an opponent off the puck, or meeting the opponent head-on, while attempting to play the puck, shall not be considered roughness. However, this does not imply that players NOT in possession of the puck may throw their bodies into an opponent in order to achieve possession.

NOTE: Penalty for unnecessary roughness (roughing) should be called in every case when an opposing player makes unnecessary contact with the player in possession of the puck.

#### 6.4.35 Penalty Shots-Awarded Goals

- a) If a player of an attacking side in possession of the puck shall be in such a position as to have no opposition between that player and the opposing goalkeeper, and while in such position that player shall be interfered with by a player of the opposing side who shall have illegally entered the game, a Penalty Shot shall be awarded against the side to which the offending player belongs.
- b) If when the opposing goalkeeper has been removed from the floor, a player of the side attacking the unattended goal is interfered with by a player who shall have entered the game illegally, an automatic goal shall be immediately awarded to the non-offending team.
- c) If the opposing goalkeeper has been removed and an attacking player in possession of the puck shall have no player of the defending team to pass and a stick or a part thereof is thrown by an opposing player or the player is fouled from behind thereby being prevented from having a clear shot on an open goal, an automatic goal shall be awarded to the non-offending team.
- d) If a defending player, except the goalkeeper, uses hands to pick up the puck from the floor in the crease area while play is in progress, the play shall be stopped immediately and a Penalty Shot shall be awarded against the offending team.
- e) If a defending player, except the goalkeeper, falls on the puck or holds the puck or gathers the puck into the body or hands when the puck is within the goal crease, the play shall immediately be stopped and a Penalty Shot shall be awarded against the offending team.

NOTE: This rule shall be interpreted so that a Penalty Shot will be awarded only when the puck is in the crease at the instant the play is stopped. However, in cases where the puck is outside the crease a Minor Penalty may be imposed even though no penalty shot is awarded.

- f) If a player (including goalkeeper) deliberately displaces the goal post to prevent a breakaway scoring opportunity by the opposing team or deliberately displaces the goal post during an ideal scoring opportunity by the opposing team, a Penalty Shot shall be awarded against the offending team. If the infraction takes place while the goalie has been replaced in the game for an extra player, an automatic goal shall be awarded to the non-offending team.
- g) When any player of the defending side, including the goalkeeper, deliberately throws the player's stick or any part thereof or any other object, at the puck in the player's defending zone, the Referee shall allow the play to be completed and if a goal is not scored a Penalty

Shot shall be awarded against the offending team. The shot shall be taken by the player designated by the Referee as the player fouled.

- h) When a player, in control of the puck in the attacking zone, and having no other opponent to pass than the goalkeeper, is tripped or otherwise fouled from behind preventing a reasonable scoring opportunity a Penalty Shot shall be awarded against the offending team. Nevertheless, the Referee shall not stop the play until the attacking side has lost possession of the puck to the defending side.

NOTE: The intention of this rule is to restore a reasonable scoring opportunity which has been lost by reason of a foul from behind when the foul is committed in the attacking zone. "Control of the puck" means the act of propelling the puck with the stick. If, while it is being propelled, the puck is touched by another player or the player's equipment or hits the goal or goes free, the player shall no longer be considered to be "in control of the puck".

- i) If, when the opposing goalkeeper has been removed from the floor (i.e. legally substituted), a player in control of the puck is tripped or otherwise fouled with no opposition between that player and the opposing goal, thus preventing a reasonable scoring opportunity, the play shall immediately be stopped and an automatic goal shall be awarded to the non-offending team.



## 7 DISCIPLINE

### 7.1 General

- a) An IHNZ Disciplinary Panel will hear all disciplinary actions that occur at any IHNZ sanctioned game or event in accordance with the IHNZ Disputes and Disciplinary Policy or as determined by the IHNZ Board.
- b) An Official's Game Report to IHNZ shall be made in the following cases:
  - A player incurring a Match Penalty shall be investigated promptly by IHNZ which shall have full power to impose such further discipline as deemed fitting.
  - A Match Penalty shall disqualify that player for the remainder of the tournament or until IHNZ investigates the matter fully. IHNZ has the authority to amend or adjust the duration of suspension in accordance with the IHNZ Disputes and Disciplinary Policy.

## 8 SANCTIONS

### 8.1 Forfeiture

a) A forfeiture of a game shall be declared for the following reasons:

- At the start of a game when the Referee's whistle is blown to commence play, a team does not have four players and a goalkeeper on the floor in full and required uniform.
- By the Team Captain submitting in writing and accepted by Tournament Director that the team will not be able to play a particular game. In this event the opposing team does not need to suit up or make appearance at the game, but shall still be awarded the victory.
- Due to injury or illness during the game a team cannot field (when at full strength) four players and a goalkeeper to continue this game.
- Due to penalties during the game a team cannot field the required number of players to continue the game.
- If a team when ordered to do so by the Referee through its Manager or Coach fails to go on the floor and start within five minutes and the case shall be reported to IHNZ for possible further action.
- If when both teams are on the floor one team for any reason shall refuse to play when ordered to do so by the Referee, the Referee shall warn the Captain or Alternate Captain and allow the team so refusing fifteen seconds within which to begin the game or resume play. If at the end of that time the team shall still refuse to play the Referee shall impose a Bench Minor Penalty to the offending team. The penalty shall be served by a player on the offending team designated by the Manager or Coach of that team through the Captain. Should there be a repetition of the same incident the Referee shall have no alternative but to declare the game forfeited to the non-offending team. The case shall be reported to IHNZ for possible further action.

Note: Refusing to Start Play is a very serious offence here. Currently, our Rules indicate that a team must return within two minutes and upon doing so, a Major and Game Misconduct Penalty is levied to the Coach for delay of game. Additionally, if the withdrawal occurs in the last two minutes or in Over Time, a Penalty Shot is also awarded. If the team fails to return within the two minutes, or is withdrawn a second time, the game is immediately suspended. Further discipline to the teams and Coaches would follow upon a written report to the IHNZ Chairperson. This also applies to situations where a player or team official is ordered to leave the game and does not do so, not only in cases of protest where the entire team is withdrawn.

b) In the event of a forfeit then the following scoring statistics shall be awarded:

- The forfeiting team shall be awarded a loss for the game. The opposing team shall be awarded two points (a victory for the game). The score of the game shall be recorded as 1 to 0. The forfeiting team (loser), while still in round-robin play, shall be penalized a minus 2 points for that game, which must be deducted from their accumulated points total for the round robin.
- The Captain of the victorious team shall be awarded one goal. (This may not be substituted to any other player) There shall be no assists awarded.
- The goalkeeper of either team shall not be credited with either a shot, save or goal against.

c) A team may forfeit one game during the round-robin portion of the tournament without disqualification of that team for the tournament. If the same team forfeits a second game in the same tournament, that team shall be disqualified for the remainder of all tournament games. Any single forfeiture occurring after completion of round-robin games, during either the medal play or the placement games will also cause a team to be disqualified for the remainder of the tournament.

- d) In the event of the removal of a team from the tournament by forfeiture the following statistical change shall take place:
- All statistics of the removed team and team players shall be removed from the official statistics. This is to include all team points, all goals scored, assists, saves, goals against, penalty minutes and all other pertinent statistics.
  - Any and all teams that have already played the forfeiting team must also have the statistics erased as though the game had not been played.

NOTE: The removal of all penalty minutes will not remove action taken or to be taken by the Tournament Director or IHNZ as to penalties assessed to forfeiting team players.

NOTE: IHNZ shall issue instructions pertaining to records etc. of a forfeited game.

## 8.2 Suspension

- a) Any player assessed a Major Penalty and a Game Misconduct Penalty automatically be removed from the balance of that game and be suspended for the next game his or her team plays unless otherwise stated in the playing rules.
- b) If a player, Coach or Manager persists after a warning from the Referee is continuing inappropriate Misconduct, that person shall be subject to suspension for a period of one year or more as determined by IHNZ.
- c) Any non-playing Coach, Manager or Team Official who gets on the floor after the start of the game without permission of the Referee shall automatically be removed from the game and assessed a Game Misconduct Penalty. That person will also be suspended for the next game his team plays. Any player who holds or strikes a Game Official shall be suspended from the remainder of the tournament.
- d) Any Manager, Coach or Team Official who holds or strikes a Game Official shall be ordered to the dressing room, and disciplinary action shall be taken by IHNZ.

## 9 DISPUTES

### 9.1 Protests

- a) A protest made to the Lead Referee will not be valid unless made on the rink by the Captain of the protesting team, and the Lead Referee will immediately inform the Captain of the opposing team. Once the Referee in charge of the match has ruled on an incident occurring during the course of play, this decision will stand unless an official letter of protest seeking to overturn this ruling is filed with the Chairperson of IHNZ or their delegated representative, along with a protest fee of \$200. IHNZ will then investigate the protest in accordance with the IHNZ Disputes and Disciplinary Policy. If the Protest is upheld, the protest fee will be returned. If it is not, then the protest fee will be forfeited.
- b) In the case of administrative protests (bad condition of the rink, player's equipment, unqualified players etc.), only those made to the Lead Referee BEFORE the start of a match are valid. The Referee will then advise the Captains of both teams that the match is being played under protest. All protests must be confirmed by official letter addressed to the Chairperson of IHNZ or their delegated representative, accompanied by the necessary fee, within one and a half (1-1/2) hours of the end of the game. When sufficient time exists prior to the start of a game for settlement of such administrative protests, these will then become under the immediate jurisdiction of IHNZ.
- c) Each participating Member Club has the right to lodge protests against any incidents (arbitrary or otherwise) which may arise during the course of any IHNZ sanctioned game or event. For a protest to be valid, it must be written and presented to the IHNZ Chairperson or their delegated representative, not later than three (3) hours after the incident.
- d) All appeals (described in 9.1a above) of the Referee's decision must be filed in writing and submitted no later than three hours after the incident to the Chairperson of IHNZ or their delegated representative, along with an appeal fee of \$200. See Article 24 of the Organisational General Rules.

### 9.2 Appeals

- a) Any appeal against the decisions of an IHNZ Disciplinary Panel on these matters must be lodged with the Chairperson of IHNZ or their delegated representative, and subsequently whose decision will be final and binding.

### 9.3 Final positioning Round-Robin Game Scoring and Tie Breakers

After round-robin, games ended in a tie will remain tied and points will be awarded as follows:

- Two (2) points to the game winner
- One (1) point for a tie game
- Zero (0) points to the loser
- Minus (-2) points for a forfeit

#### **Two team Tie Breaker**

1. **Most Points**-The placement of teams within each pool shall be according to the *most number of points accumulated in round-robin play*. If after addition of points, two or more teams are determined to possess an equal amount of points in the round robin, the team's position is determined as follows, in the following order:
2. **Head to Head**-The victor of the head-to-head competition in the round-robin shall be awarded the higher placement position.
3. **Most Wins**-If a tie remains, the highest total of wins among the tied teams, during all games in the round robin.
4. **Goal Differential**-If a tie remains, the best goals differential between goals-scored and goals-against in the round robin. (ex. GS 8, GA 3-Result +5).
5. **Goals against**-If a tie still results, the team with the lowest total number of goals-against for the entire round robin shall be used to determine position for the tied teams.
6. **Goals for**-If a tie still results, the highest total of goals scored for the entire round robin shall be used to determine position for the tied teams.

7. **Shootout**-If teams are tied after applying the above criteria, a shoot-out will take place as defined in Rule 1.3e.

### ***Three or more team Tie Breaker***

1. **Most Points**-The placement of teams within each pool shall be according to the *most number of points accumulated in the round-robin*. If after addition of points, two or more teams are determined to possess an equal amount of points in round robin, the team's position is determined as follows, in the following order:
2. **Most Wins**-If a tie remains, the highest total of wins among the tied teams, during all games in the round robin.
3. **Partial Goal Differential**-If a tie remains, the best goals differential between goals-scored and goals-against among the tied teams.
4. **Total Goal Differential**-If a tie remains, the best goals differential between goals-scored and goals-against in the round robin.
5. **Goals against**-If a tie still results, the team with the lowest total number of goals-against for the entire round robin shall be used to determine position for the tied teams.
6. **Goals for**-If a tie still results, the highest total of goals scored for the entire round robin shall be used to determine position for the tied teams.

When one team is eliminated in the criteria listed above, the remaining teams (if three more than two) will start from Point 1 Most Wins.

When there are only two teams remaining, they will revert to the Two Team Tie breaker criteria.

# Annex A RINK DIAGRAM 50 m x 25 m

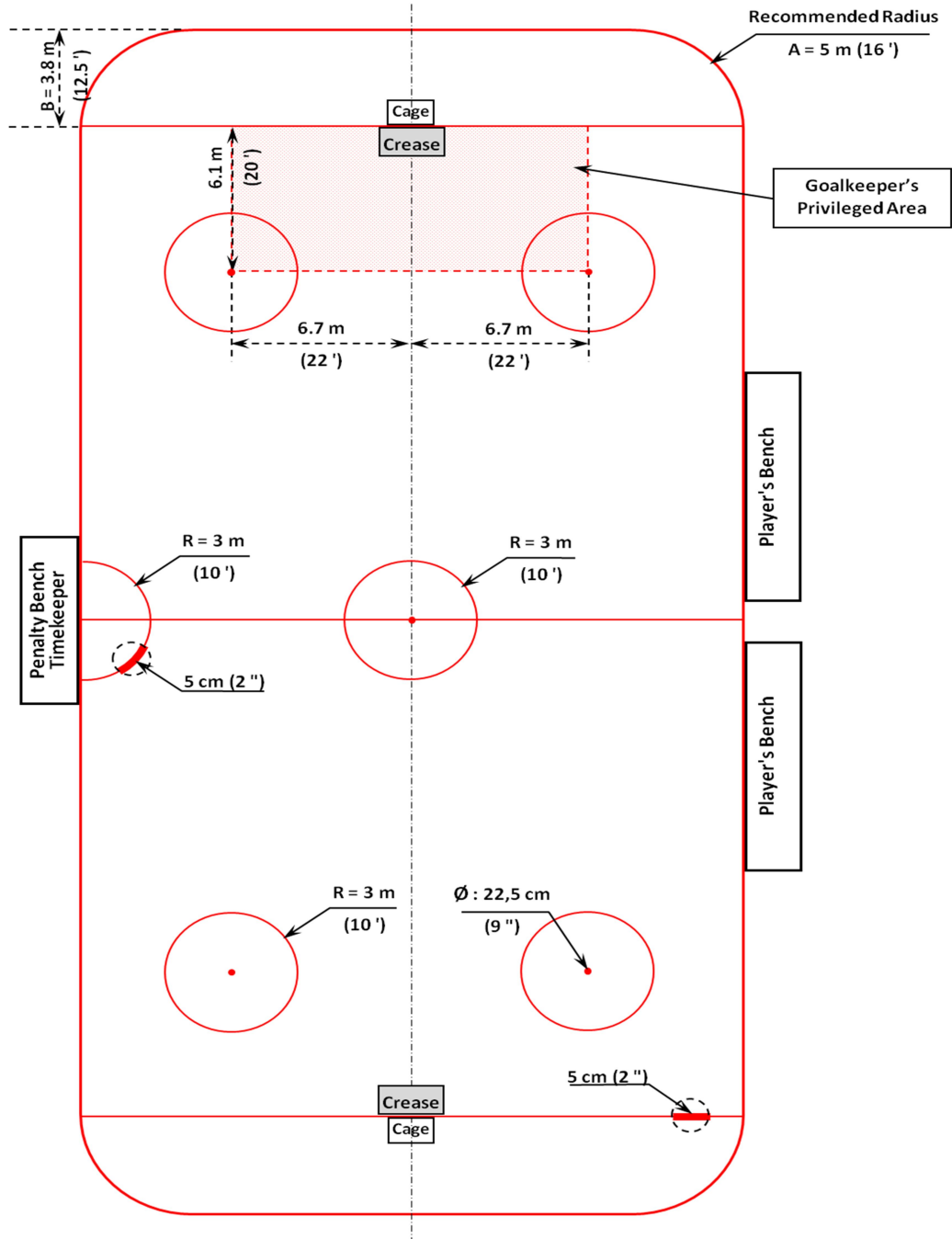

Rink Size	60 m x 30 m	197' x 98'	<b>50 m x 25 m</b>	<b>164' x 82'</b>	40 m x 20 m	131' x 66'
A	6 m	19.7'	<b>5 m</b>	<b>16.4'</b>	4 m	13'
B	4.6 m	15'	<b>3.8 m</b>	<b>12.5'</b>	3 m	10'

## GOAL CREASE DIAGRAM

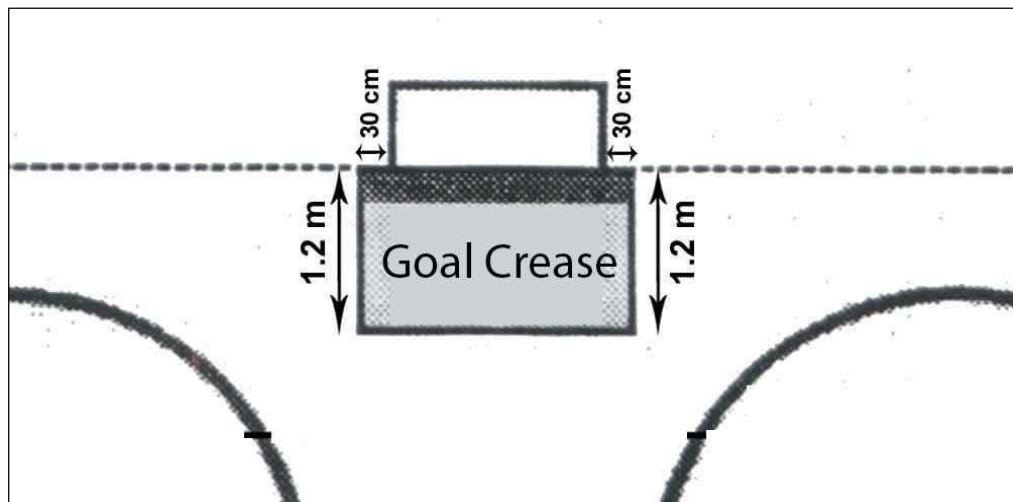

## LEGAL HAND PASS AREA FOR THE GOALKEEPER

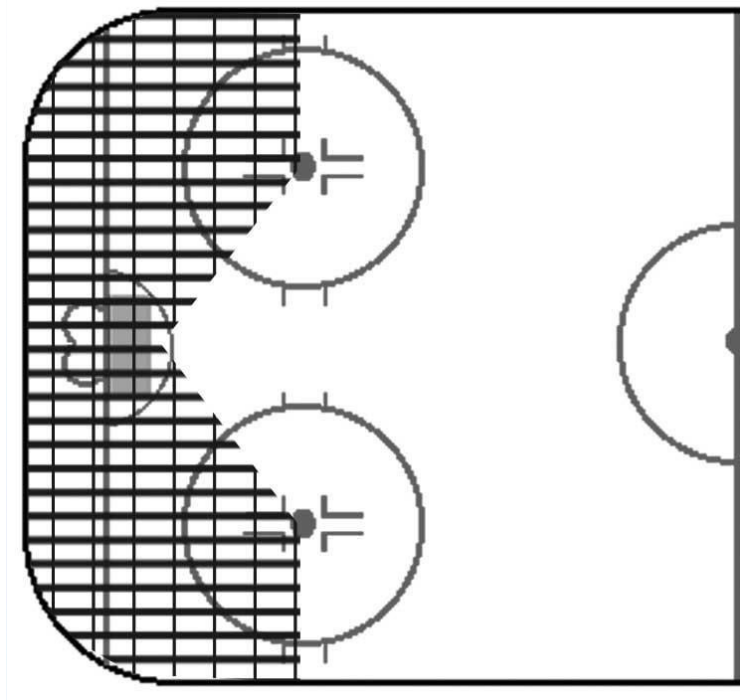

Goalkeeper may pass the puck to a team mate only in the marked area. The pass may start in the marked area but must be completed in the marked area. If the pass is received outside the marked area it is considered a violation of the rule.

# GOAL CAGE DIAGRAM

All framework is to be constructed of galvanized iron pipe conforming to the specified diameters and dimensions of these diagrams.

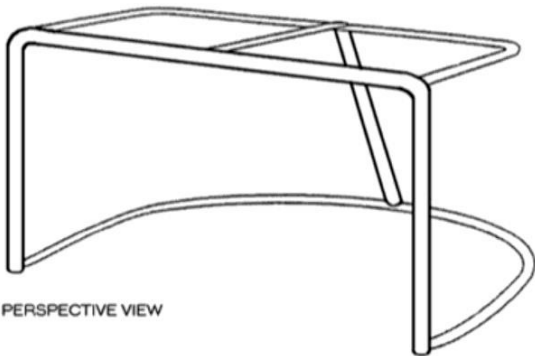

PERSPECTIVE VIEW

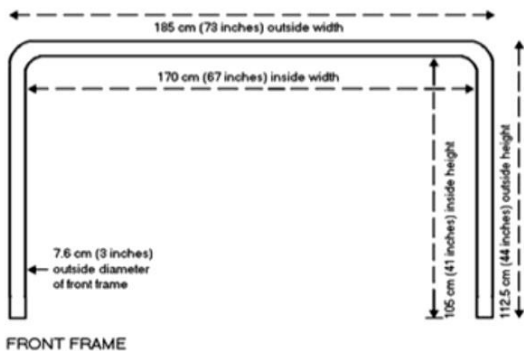

FRONT FRAME

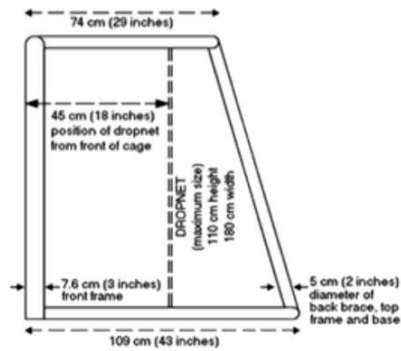

SIDE VIEW

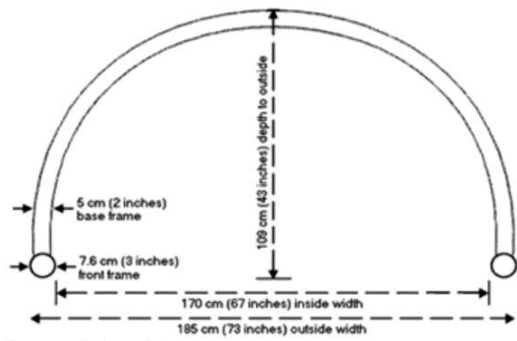

BASE STRUCTURE

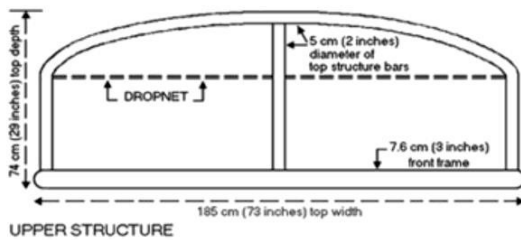

UPPER STRUCTURE



## Annex B Penalty Signals

Boarding



Strike the clenched fist of one hand into the open palm of the other hand in front of the chest.

Body Checking



The non-whistle hand is placed on the shoulder and then moved out and to the side.

Butt-Ending



A crossing motion of the forearms, one moving under the other.

Charging



Rotating clenched fists around one another in front of the chest.

Cross Checking



A single forward and back motion with both fists clenched in front of the chest.

Checking from Behind



Both open hands extended out from the body in a pushing motion.

Delayed Penalty



The extension of the non-whistle arm above the body with an open palm. Fingers are together.

Delay of Game



The non-whistle hand, palm open, is placed across the chest and then fully extended.

Elbowing



Tapping either elbow with the opposite hand.

Roughing

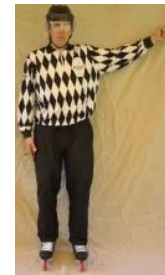

Fist clenched, fully extending the arm out from the body.

Goal Scored



Point at the net with the non-whistle hand.

Hand Pass



The non-whistle hand with an open palm pushed out away from the body.

Misconduct



Both hands placed on the hips.

Match



The non-whistle hand placed on the top of the helmet.

High-Sticking



Holding both fists one above the other to the body.

Hooking



A tug of both closed fists in toward the front of the body.

Holding



Grasping the wrist of the whistle hand in front of the body.

Interference



Crossed arms with both fists closed in front of the body.

Kneeing

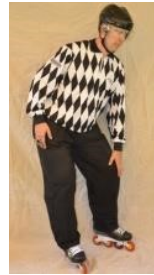

The non-whistle hand placed on the knee with both skates on the surface.

Slashing

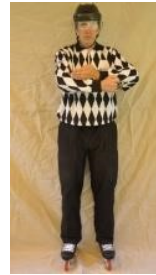

A chop to the forearm of the whistle hand with the non-whistle hand.

Penalty Shot



Crossed arms above the head with closed fists.

Tripping



Keeping both skates on the surface swipe the non-whistle hand to the knee.

Timeout



Using both hands, form a 'T' in front of the chest.

Spearing



A single jab with both arms extending out from the body.

Unsportsmanlike

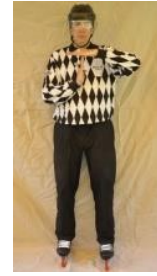

Using both hands, form a 'T' in front of the chest.

Washout



Both arms fully extended out from the body with open arms.

## Annex C

### PENALTY INDEX

DESCRIPTION	RULE	DURATION
Adjustment to Clothing and Equipment	6.4.5	2'
Boarding	6.4.13	2'
Broken Stick	6.4.11	2'
Charging	6.4.12a	2'
Delaying the Game	6.4.16	2'
Elbowing or Kneeing	6.4.17	2'
Face Off Violation	6.4.4	2'
Falling on the Puck	6.4.18a	2'
Goalkeeper Penalties	6.4.7	2'
Handling Puck with Hand	6.4.20a,b	2'
Holding	6.4.22a	2'
Hooking	6.4.23a	2'
Illegal Equipment (Goalkeeper)	6.4.3d	2'
Illegal Equipment (Protective equipment)	6.4.3c	2'
Illegal Equipment (Skates)	6.4.3b	2'
Illegal Equipment (Sticks)	6.4.3a	2'
Illegal Substitution	4.6c	2'
Interference	6.4.24a	2'
Interference with Goalkeeper	6.4.24c	2'
Leaving the Player or Penalty Benches	6.4.27b	2'
Refusal to Start Play	8.1a	2'
Roughing	6.4.34a	2'
Tripping	6.4.33a	2'
Stick Swung above shoulder	4.21c	2'
Slashing	6.4.30a	2'
Cross Checking	4.14a	2'
High Sticks	6.4.21c	2'
Spearing and Butt-Ending (attempted)	4.31a	2+2'
Three Stick Penalties	6.1.7c	GE
Cross Checking *	4.14b	5'+GM
Cross Checking causing Injury	4.14c	5'+GM
Cross Checking Goalkeeper with in the crease	4.14b	5'+GM
Slashing *	6.4.30b	5'+GM
Slashing causing Injury	6.4.30b	5'+GM
High Sticks *	6.4.21d	5'+GM
High Sticks causing Injury	6.4.21e	5'+GM
Slashing during Altercation	6.4.30c	MP
Spearing and Butt-Ending causing Injury	4.31b	MP
Leaving the Player or Penalty Benches( During a fight or for purpose of starting a fight)	6.4.27f	2+2+GM
Throwing Stick	6.4.32a	2'+GM
Boarding *	6.4.13	5'+GM
Charging *	6.4.12a	5'+GM
Charging Goalkeeper within the goal crease	6.4.12b	5'+GM
Checking From Behind	6.4.26a	5'+GM

Fighting (Starting)	6.4.19b	5'+GM
Holding *	6.4.22a	5'+GM
Holding Causing Injury	6.4.22b	5'+GM
Hooking *	6.4.23a	5'+GM
Hooking Causing Injury	6.4.23b	5'+GM
Interference *	6.4.24a	5'+GM
Roughing *	6.4.34a	5'+GM
Throwing Stick	6.4.32b	5'+GM
Tripping *	6.4.33a	5'+GM
Tripping causing Injury	6.4.33b	5'+GM
Roughing causing Injury	6.4.34b	5'+GM
Elbowing or Kneeing *	6.4.17a	5'+GM
Elbowing or Kneeing causing Injury	6.4.17b	5'+GM
Fighting (Intervene in fight)	6.4.19e	GM
Fighting (off the playing surface)	6.4.19d	GM
Goalkeeper leaves goal crease for Altercation	6.4.7f	GM
Incite Opponent after warning	6.4.9e	GM
Interfere with Official	6.4.9j	GM
Obscene or Profane Language or Gestures	6.4.29	GM
Resistance to Serve Penalty	6.4.9d	GM
Resists Referee in Duties	6.4.9j	GM
Second Misconduct same game	6.1.7d	GM
Shooting the puck out of the reach of an official	6.4.9b	MIS
Throwing Object on Skating Surface	6.4.9i	GM
Attempt to Injure	6.4.10	MP
Checking From Behind (Boarding or Goal Cage)	6.4.26b	MP
Fighting (Intent to injure)	6.4.19g	MP
Kicking Opponent	6.4.15c	MP
Physical Abuse of Officials	6.4.28a,b,c	MP
Deliberate Injury to Opponents	6.4.15a	MP
Deliberate Displacement of the Goal Post	6.4.8	PS
Penalty Shots-Awarded Goals	6.4.35	
Banging Boards	6.4.9c	10'
Entering the Referee Crease without permission	6.4.9k	10'
Protest	6.4.2	10'
Resistance to Serve Penalty	6.4.9d	10'
Third Minor Penalty	6.1.7a	10'
Interference by Spectators	6.4.25	Face off report to authority
Subsequent Penalty	6.1.7b	GE